

ÉNOSI EVO

Design
NIKOLAS CHACHAMIS

Engineering
C.S.R. LAS MOBILI

ÉNOSI EVO

Conforme al DLGS 81/2008 (già 626/'94)
apply to RULE 81/2008 (626/'94)

IMPORTANTE / it's very important

SULL'ORDINE INDICARE SEMPRE IL CODICE COMPLETO A 9 CIFRE
always indicate on the order the complete 9-digit code

ESEMPIO: PER ORDINARE 1 SCRIVANIA **ART.304** BIANCO BR. INDICARE IL CODICE = **156** **304** **400**
example: to order 1 DESK **ART.304** BR.WHITE indicate the code =

DECODIFICA → MODELLO ARTICOLO CODICE FINITURA (*)
decoding → model articolo finish code (*)



Certif. n°07-08/2019

In vigore dal:
Valid from:
01/01/2018

Valido fino a nuova emissione
Valid until new emission

SOMMARIO / summary

CARTELLA COLORI	3
<i>colours samples card</i>	
SCRIVANIE DIREZIONALI E ALLUNGO	5
<i>executive desks and extension</i>	
SCRIVANIE DIREZIONALI CON PIANO IN VETRO TEMPERATO RETROLACCATO	6
<i>executive desks with tempered rear-lacquered glass top</i>	
MODESTY PANELS	7
<i>modesty panels</i>	
TAVOLI RIUNIONE	8
<i>meeting tables</i>	
TAVOLI RIUNIONE CON PIANO IN VETRO TEMPERATO RETROLACCATO	10
<i>meeting tables with tempered rear-lacquered glass top</i>	
MOBILI DI SERVIZIO SU PIEDINI	12
<i>service units on adjustable feet</i>	
CASSETTIERE E MOBILI DI SERVIZIO SU RUOTE	13
<i>pedestals and service units on wheels</i>	
"BUSSOLOTTI" componibili in larghezza e altezza	14
<i>modular units</i>	
BASI, FIANCHI FINALI E TOP PER BUSSOLOTTI	15
<i>bases, final side panels and top for modular units</i>	
MOBILI BASSI	16
<i>low cabinets</i>	
MOBILI MEDI	17
<i>medium cabinets</i>	
MOBILI ALTI	18
<i>high cabinets</i>	
BASI, TOPS E FIANCHI FINALI	21
<i>bases, tops and final side panels</i>	
COMPOSIZIONI	22
<i>typicals</i>	
DESCRIZIONE TECNICA	23
TECHNICAL DESCRIPTION	24
INDICE DEI CODICI	25
<i>codes index</i>	

CARTELLA COLORI
colours samples card

LEGNI | WOOD

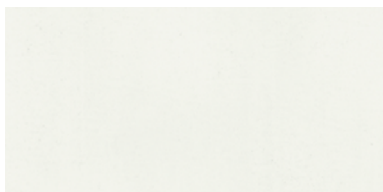

COD. 69
BIANCO BR. | BR. WHITE ○

SOLO PER STRUTTURA
MOBILI CONTENITORI
only for cabinets structure



COD. 29
NOCE ITALIA | ITALY WALNUT △



COD. 61
ROVERE AFRO | AFRICAN OAK △



COD. 37
NOCE PACIFIC | PACIFIC WALNUT △

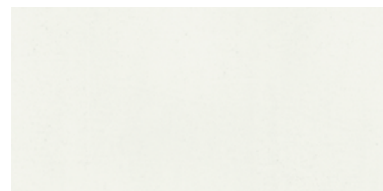

COD. 69
BIANCO BR. | BR. WHITE △



COD. 00
ALLUMINIO MILLERIGHE | ALUMINIUM STRIPED EFFECT △



COD. 45
WENGÉ | WENGÉ △



COD. 91
ACERO | MAPLE △

VETRI | GLASS



COD. 10
NERO | BLACK



COD. 74
ROSSO RUBINO | RUBY RED



COD. 78
BIANCO EXTRA | EXTRA WHITE



COD. 75
PISTACCHIO | PISTACHIO

METALLI | METALS

GAMBE VERNICIATE
painted legs

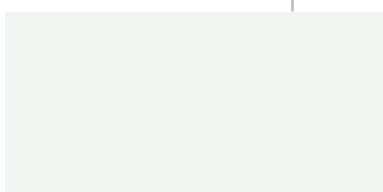

COD. BI 02 (RAL 9016)
BIANCO | WHITE



COD. NR 02
NERO | BLACK

GAMBE CROMATE
chromed legs

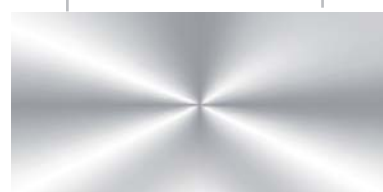

COD. CR 01
CROMATO | CHROMED

RISPONDEZZA PIANI DI LAVORO ÉNOSI EVO AL DLGS 81/2008 (ex 626/94)
conformity of ÉNOSI EVO work tops to the rules 81/2008 (ex 626/94)

A) REQUISITO DELL'ALLEGATO XXXIV / requirement of the annex XXXIV : **"IL PIANO DI LAVORO DEVE AVERE SUPERFICIE A BASSO INDICE DI RIFLESSIONE"**
"the top surface cannot be very reflecting".

TIPI DI FINITURA ENOSI EVO kind of ENOSI EVO finishing	OPACITA' / opacity	COLORE / colour	◀ NORMA UNI DI RIFERIMENTO / reference of UNI rule ◀ VALORI DI RIFERIMENTO / reference values
	UNI 9149:87	UNI 8941/2:87	
	≤ 45 GLOSS	≥ 15% ≤ 75%	
	VALORE GLOSS / gloss value	VALORE Y / value y	
3D-FOIL	NOCE ITALIA / ITALY walnut	10,0	compreso tra 15% e 75% / included between 15% and 75%
	NOCE PACIFIC / pacific walnut	10,0	compreso tra 15% e 75% / included between 15% and 75%
	WENGE' / wenge	25,0	
	ROVERE AFRO / african oak	20,0	
	BIANCO BR. / br. white	10,0	compreso tra 15% e 75% / included between 15% and 75%
	ACERO / maple	10,0	compreso tra 15% e 75% / included between 15% and 75%

B) REQUISITO DELL'ALLEGATO XXXIV / requirement of the annex XXXIV :

**"IL PIANO DI LAVORO DEVE ESSERE STABILE, DI DIMENSIONI SUFFICIENTI....
 LO SPAZIO DEVE PERMETTERE L'ALLOGGIAMENTO E IL MOVIMENTO DEGLI ARTI INFERIORI.....
 LA PROFONDITA' DEL PIANO DEVE ESSERE TALE DA ASSICURARE UN'ADEGUATA DISTANZA VISIVA DALLO SCHERMO".**
*"The work top must be stable and it must have sufficient dimensions....
 There must be enough space for the movement of the legs.
 The depth of the top must provide for an adequate visual distance from the screen".*

NORMA UNI DI RIFERIMENTO / reference of the UNI rule

- -- UNI EN 527-1 :2000 (3-3.1-3.2-3.3) -- DIMENSIONI DELLA SUPERFICIE DI LAVORO / dimension of desk tops
- △ -- UNI EN 527-1 :2000 (4-4.1-4.2-4.3) -- ALTEZZA DELLA SUPERFICIE DI LAVORO / high of desk tops
- -- UNI EN 527-1 :2000 (5-5.1-5.2) -- SPAZIO PER LE GAMBE / area for legs
- ⊙ -- UNI EN 527-2 :2003 -- GENERALITA' / general remarks

DIMENSIONI DEI PIANI DI LAVORO / dimension of the work tops

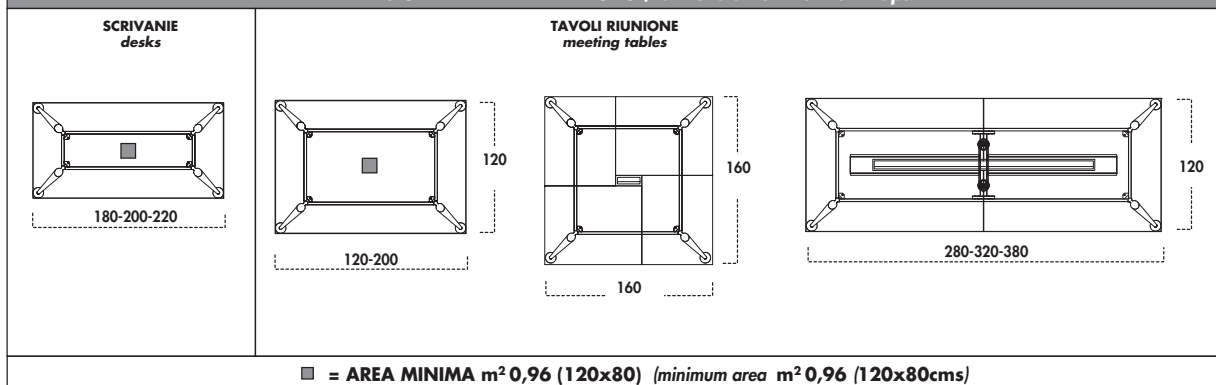

ALTEZZE SCRIVANIE CON BASAMENTO METALLICO
desks height with metallic base

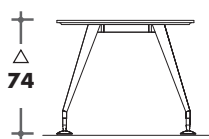

SPAZIO MINIMO UTILE TRA I FIANCHI SU TUTTE LE SCRIVANIE
minimum space between the sides on all desks

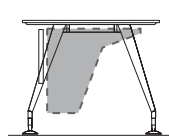

DISTANZA MINIMA TRA I FIANCHI
minimum distance between the sides

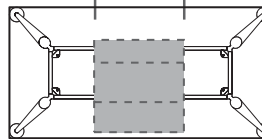

SEZIONE / section

PIANTA / plan

SCRIVANIE DIREZIONALI E TAVOLI RIUNIONE
directional desks and meeting tables

SEZIONE PIANO RIVESTITO IN 3D-FOIL
section of coated 3D-FOIL top

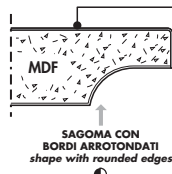

FOGLIA POLIMERICA:
 NOCE ITALIA
 NOCE PACIFIC
 WENGE'
 ROVERE AFRO
 BIANCO BR.
 ACERO

H. D. P. C.:
 ITALY walnut
 pacific walnut
 wenge
 african oak
 br. white
 maple

SEZIONE PIANO IN VETRO
section of the glass top

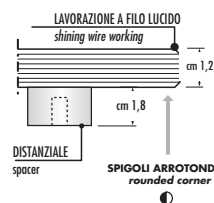

I DATI SOPRA INDICATI CONSENTONO DI DEFINIRE LE SCRIVANIE ENOSI EVO CONFORMI ALLE PRESCRIZIONI DEL DLGS 81/2008
the above mentioned information permits to determine the ENOSI EVO desks in conformity with the rules of 81/2008

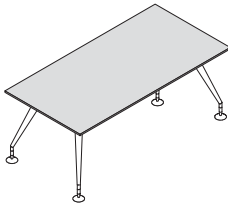
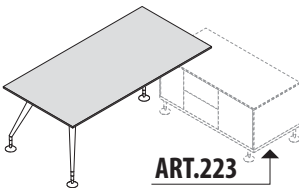
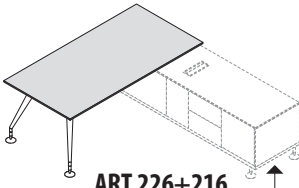
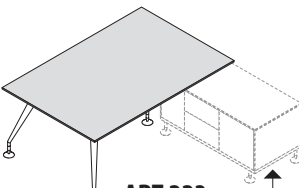
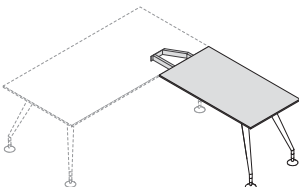
SCRIVANIE DIREZIONALI E ALLUNGO executive desks and extension								
DESCRIZIONE description	L w	CODICE code	KG	M ³	COLLI	PREZZO price	PREZZO price	(*) CODICE FINITURA (*) finish code
SCRIVANIE DIREZIONALI executive desks  L. x p.90 x H.74						GAMBE VERNICIATE ★ painted legs	GAMBE CROMATE ○ chromed legs	
	L180	156 303 (*)	65	0,196	6	€ 867,00	€ 1.047,00	
	L200	156 304 (*)	72	0,210	6	€ 919,00	€ 1.099,00	
	L220	156 305 (*)	77	0,224	6	€ 967,00	€ 1.147,00	
SCRIVANIE DIREZIONALI DX O SX (CON 1 DISTANZIALE) right or left executive desks (with 1 short leg)  ART.223 L. x p.90 x H.74								
	L180	156 313 (*)	63	0,183	6	€ 839,00	€ 990,00	
	L200	156 314 (*)	70	0,197	6	€ 891,00	€ 1.042,00	
	L220	156 315 (*)	75	0,212	6	€ 939,00	€ 1.090,00	
COMPLETARE SEMPRE CON 1 MOBILE DI SERVIZIO SU PIEDINI ART.223 (VEDI PAG.12) always complete with 1 service unit on adjustable feet ART.223 (please see page 12)								
SCRIVANIE DIREZIONALI DX O SX (CON 2 DISTANZIALI) right or left executive desks (with 2 short legs)  ART.226+216 L. x p.90 x H.74								
	L180	156 318 (*)	61	0,171	6	€ 811,00	€ 933,00	
	L200	156 319 (*)	68	0,185	6	€ 863,00	€ 985,00	
	L220	156 320 (*)	73	0,199	6	€ 911,00	€ 1.033,00	
COMPLETARE SEMPRE CON 1 MOBILE DI SERVIZIO SU PIEDINI ART.226+216 (VEDI PAG.12) always complete with 1 service unit on adjustable feet ART.226+216 (please see page 12)								
SCRIVANIE DX O SX (CON 1 DISTANZIALE) right or left desks (with 1 short leg)  ART.223 oppure /or ART.226+216 L. x p.120 x H.74	L200	156 373 (*)	94	0,254	6	€ 945,00	€ 1.096,00	
	COMPLETARE SEMPRE CON 1 MOBILE DI SERVIZIO SU PIEDINI (VEDI PAG.12) always complete with 1 service unit on adjustable feet (please see page 12)							
ALLUNGO DX O SX right or left extension  L. x p.65 x H.74	L100	156 323 (*)	27	0,105	4	€ 450,00	€ 540,00	
	L120	156 324 (*)	31	0,112	4	€ 488,00	€ 578,00	

★ GAMBE VERNICIATE/painted legs			
(*)	PIANO	GAMBE	top legs
400	BIANCO BR.	BIANCO	br. white white
418	NOCE PACIFIC	BIANCO	pacific walnut white
419	NOCE ITALIA	BIANCO	italy walnut white
420	ACERO	BIANCO	maple white
429	ROVERE AFRO	BIANCO	african oak white
490	WENGÉ	BIANCO	wenge white
518	NOCE PACIFIC	NERO	pacific walnut black
519	NOCE ITALIA	NERO	italy walnut black
520	ACERO	NERO	maple black
529	ROVERE AFRO	NERO	african oak black
540	BIANCO BR.	NERO	br. white black
590	WENGÉ	NERO	wenge black

○ GAMBE CROMATE/chromed legs			
918	NOCE PACIFIC	CROMATO	pacific walnut chromed
919	NOCE ITALIA	CROMATO	italy walnut chromed
920	ACERO	CROMATO	maple chromed
929	ROVERE AFRO	CROMATO	african oak chromed
940	BIANCO BR.	CROMATO	br. white chromed
990	WENGÉ	CROMATO	wenge chromed

ÉNOSI EVO

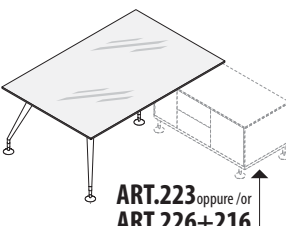
SCRIVANIE DIREZIONALI E ALLUNGO CON PIANO IN VETRO TEMPERATO RETROLACCATO <i>executive desks and extension with tempered rear-lacquered glass top</i>												
DESCRIZIONE <i>description</i>	L <i>w</i>	CODICE <i>code</i>	KG	M ³	COLLI	PREZZO <i>price</i>	PREZZO <i>price</i>	(*) CODICE FINITURA <i>(*) finish code</i>				
SCRIVANIE DX O SX CON PIANO IN VETRO (CON 1 DISTANZIALE) <i>right or left desks with glass top (with 1 short leg)</i>		VETRO COLORATO coloured glass				GAMBE VERNICIATE ★ <i>painted legs</i>	GAMBE CROMATE ○ <i>chromed legs</i>	★ GAMBE VERNICIATE / <i>painted legs</i>				
								(*)	PIANO <i>top</i>	GAMBE <i>legs</i>		
 ART.223 oppure /or ART.226+216	L.200	156 420 (*)	120	0,301	7	€ 1.427,00	€ 1.578,00	410	NERO	BIANCO	black	white
								474	ROSSO RUBINO	BIANCO	ruby red	white
								475	PISTACCHIO	BIANCO	pistachio	white
								510	NERO	NERO	black	black
								574	ROSSO RUBINO	NERO	ruby red	black
								575	PISTACCHIO	NERO	pistachio	black
								○ GAMBE CROMATE / <i>chromed legs</i>				
								910	NERO	CROMATO	black	chromed
								974	ROSSO RUBINO	CROMATO	ruby red	chromed
								975	PISTACCHIO	CROMATO	pistachio	chromed
								★ GAMBE VERNICIATE / <i>painted legs</i>				
		VETRO BIANCO EXTRA extra white glass						(*)	PIANO <i>top</i>	GAMBE <i>legs</i>		
	L.200	156 443 (*)	120	0,301	7	€ 1.663,00	€ 1.814,00	478	BIANCO EXTRA	BIANCO	extra white	white
								578	BIANCO EXTRA	NERO	extra white	black
								○ GAMBE CROMATE / <i>chromed legs</i>				
								978	BIANCO EXTRA	CROMATO	extra white	chromed
COMPLETARE SEMPRE CON 1 MOBILE DI SERVIZIO SU PIEDINI (VEDI PAG.12) <i>always complete with 1 service unit on adjustable feet (please see page 12)</i>												
								★ GAMBE VERNICIATE / <i>painted legs</i>				
								(*)	PIANO <i>top</i>	GAMBE <i>legs</i>		
ALLUNGO DX O SX CON PIANO IN VETRO <i>right or left extension with glass top</i>	L.100	156 413 (*)	27	0,121	5	€ 578,00	€ 668,00	410	NERO	BIANCO	black	white
								474	ROSSO RUBINO	BIANCO	ruby red	white
								475	PISTACCHIO	BIANCO	pistachio	white
								510	NERO	NERO	black	black
								574	ROSSO RUBINO	NERO	ruby red	black
								575	PISTACCHIO	NERO	pistachio	black
								○ GAMBE CROMATE / <i>chromed legs</i>				
								910	NERO	CROMATO	black	chromed
								974	ROSSO RUBINO	CROMATO	ruby red	chromed
								975	PISTACCHIO	CROMATO	pistachio	chromed
								★ GAMBE VERNICIATE / <i>painted legs</i>				
		VETRO BIANCO EXTRA extra white glass						(*)	PIANO <i>top</i>	GAMBE <i>legs</i>		
	L.100	156 436 (*)	27	0,121	5	€ 639,00	€ 729,00	478	BIANCO EXTRA	BIANCO	extra white	white
								578	BIANCO EXTRA	NERO	extra white	black
								○ GAMBE CROMATE / <i>chromed legs</i>				
								978	BIANCO EXTRA	CROMATO	extra white	chromed
								★ GAMBE VERNICIATE / <i>painted legs</i>				
								(*)	PIANO <i>top</i>	GAMBE <i>legs</i>		
	L.100	156 436 (*)	27	0,121	5	€ 639,00	€ 729,00	478	BIANCO EXTRA	BIANCO	extra white	white
								578	BIANCO EXTRA	NERO	extra white	black
								○ GAMBE CROMATE / <i>chromed legs</i>				
								978	BIANCO EXTRA	CROMATO	extra white	chromed

ENOSI EVO

MODESTY PANELS <i>modesty panels</i>										
DESCRIZIONE <i>description</i>	L <i>w</i>	L <i>w</i>	CODICE <i>code</i>	KG	M ³	COLLI	PREZZO <i>price</i>	(*) CODICE FINITURA <i>(*) finish code</i>		
MODESTY PANEL PER SCRIVANIE PROF.90-120 <i>modesty panel for desks deep 90-120 cms</i>								(*)		
								MODESTY PANEL	modesty panel	
								000	ALLUMINIO MILLERIGHE	aluminium striped effect
								180	NOCE PACIFIC	pacific walnut
								190	NOCE ITALIA	italy walnut
								200	ACERO	maple
								290	ROVERE AFRO	african oak
								400	BIANCO BR.	br. white
								900	WENGÉ	wenge
								I MODESTY PANELS SONO UTILIZZABILI SU SCRIVANIE CON PIANI RIVESTITI IN 3D-FOIL E CON PIANI IN VETRO! <i>the modesty panels are suitable for desks with both 3D-FOIL and glass top!</i>		
		LUNGHEZZA PIANO width top	LUNGHEZZA MODESTY width modesty panel							
	L.180	L.112,7	156 396 (*)	10	0,024	2	€ 72,00			
	L.200	L.132,7	156 397 (*)	11	0,027	2	€ 80,00			
	L.220	L.152,7	156 398 (*)	12	0,033	2	€ 88,00			

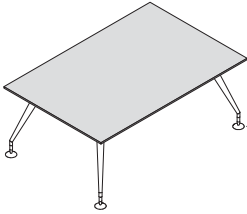
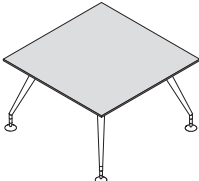
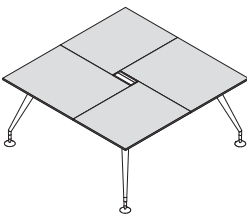
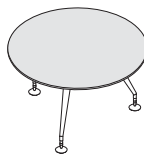

TAVOLI RIUNIONE meeting tables								
DESCRIZIONE description	L w	CODICE code	KG	M ³	COLLI	PREZZO price	PREZZO price	(*) CODICE FINITURA (* finish code)
TAVOLI RIUNIONE/SCRIVANIE meeting tables/desks  L. x p.120 x H.74	L.200	156 352 (*)	96	0,266	6	GAMBE VERNICIATE ★ painted legs	GAMBE CROMATE ○ chromed legs	
						€ 973,00	€ 1.153,00	
TAVOLO RIUNIONE QUADRATO L.120xp.120 squared meeting table w 120 x d 120 cms  L.120 x p.120 x H.74	L.120	156 374 (*)	66	0,184	6	★ GAMBE VERNICIATE / painted legs		
						€ 763,00	€ 943,00	
TAVOLO RIUNIONE QUADRATO L.160xp.160 CON CANALE PORTA-CAVI E TOP ACCESS squared meeting table w 160 x d 160 cms with cable tray and top access  L.160 x p.160 x H.74	L.160	156 375 (*)	99	0,304	10	○ GAMBE CROMATE / chromed legs		
						€ 1.547,00	€ 1.727,00	
TAVOLO RIUNIONE CIRCOLARE Ø120 circular meeting table Ø 120 cms  Ø 120 x H.74	Ø120	156 376 (*)	54	0,144	5			
						€ 643,00	€ 778,00	

TAVOLI RIUNIONE meeting tables																
DESCRIZIONE description	L w	CODICE code	KG	M ³	COLLI	PREZZO price	PREZZO price	(*) CODICE FINITURA (*) finish code								
TAVOLO RIUNIONE RETTANGOLARE L280 (CON WIRE-MANAGER, CANALE PORTA-CAVI E TOP ACCESS) rectangular meeting table w 280 cms (with wire-manager, cable tray and top access)	L280	156 379 (*)	139	0,469	9	€ 1.749,00	€ 1.929,00									
									GAMBE VERNICIATE ★ painted legs		GAMBE CROMATE ○ chromed legs					
									★ GAMBE VERNICIATE / painted legs							
TAVOLO RIUNIONE RETTANGOLARE (CON WIRE-MANAGER, CANALE PORTA-CAVI E TOP ACCESS) rectangular meeting table (with wire-manager, cable tray and top access)	L320	156 380 (*)	167	0,640	10	€ 2.199,00	€ 2.379,00									
									L380	156 381 (*)	192	0,699	11	€ 2.477,00	€ 2.657,00	
PASSACAVO Ø80MM cable way Ø 80 mm		175 392 (*)		1,5		0,002		1								
CANALE PORTA-CAVI cable tray	L29	156 393 (*)	2	0,009	1	€ 21,00			(*)		000 ARGENTO silver					

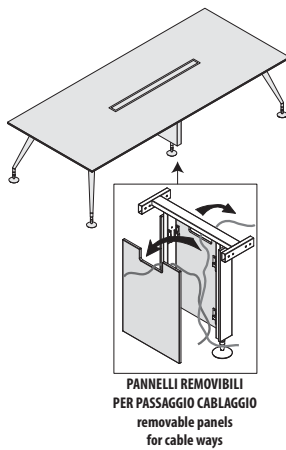

L.280 x p.120 x H.74

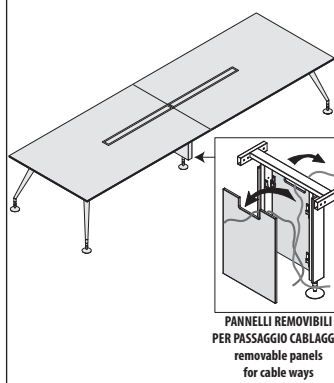

L. x p.120 x H.74

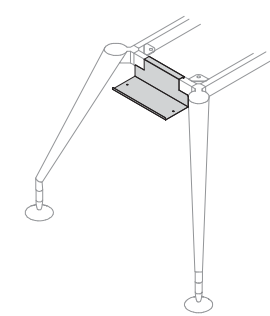
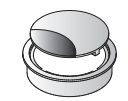

L.29 x p.15 x H.10,6

ÉNOSI EVO

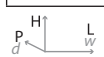

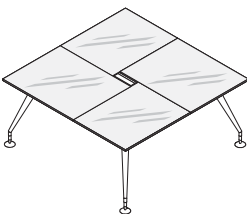
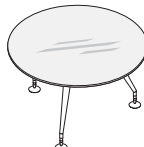
TAVOLI RIUNIONE CON PIANO IN VETRO TEMPERATO RETROLACCATO								
meeting tables with tempered rear-lacquered glass top								
DESCRIZIONE description	L w	CODICE code	KG	M ³	COLLI	PREZZO price	PREZZO price	
TAVOLO RIUNIONE QUADRATO L.160x1.60 PIANO IN VETRO, CANALE PORTA-CAVI E TOP ACCESS squared meeting table w 160 x d 160 cms with glass top, cable tray and top access  L.160 x p.160 x H.74								
TAVOLO RIUNIONE CIRCOLARE Ø120 CON PIANO IN VETRO circular meeting table Ø 120 cms with glass top  Ø 120 x H.74								

ÉNOSI EVO

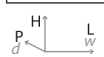

MOBILI DI SERVIZIO SU PIEDINI																												
service units on adjustable feet																												
DESCRIZIONE description	L w	CODICE code	KG	M ³	COLLI	PREZZO price	(*) CODICE FINITURA (*) finish code																					
<p>MOBILE DI SERVIZIO L.122,5 DX O SX SU PIEDINI right or left service unit w 122,5 on adjustable feet</p> <p>L.122,5 x p.60 x H.59,7</p>	L.122,5	156 223 (*)	73	0,355	8	€ 919,00																						
	<p>DIMENSIONI VANO INTERNO PORTA-CPU (PER MINI-TOWER): L.26,3x p.53,8 x H.43,2 internal dimensions compartment CPU-STAND (for mini-tower): w 10¼"x d.21¼" x h.17"</p>																											
<p>MOBILE DI SERVIZIO L.212,3 DX O SX SU PIEDINI right or left service unit w 212,3 on adjustable feet</p> <p>L.212,3 x p.60 x H.59,7</p> <p>ELEMENTO LIBRERIA ART.216 pag.14 modular bookcase ART.216 page 14</p>	L.212,3	156 226 (*)	83	0,385	8	€ 1.052,00																						
	<p>DIMENSIONI VANO INTERNO PORTA-CPU (PER MINI-TOWER): L.26,3x p.53,8 x H.43,2 internal dimensions compartment CPU-STAND (for mini-tower): w 26,3 x d.53,8 x h.43,2</p>																											
	<p>COMPLETARE SEMPRE CON 1 ELEMENTO LIBRERIA ART.216 (VEDI PAG.14) always complete with 1 modular bookcase art.216 (please see page 14)</p>																											
							<table border="1"> <thead> <tr> <th>(*)</th> <th>FRONTALI - BASE FIANCHI FINALI - TOP</th> <th>fronts - base final side panels - top</th> </tr> </thead> <tbody> <tr> <td>918</td> <td>NOCE PACIFIC</td> <td>pacific walnut</td> </tr> <tr> <td>919</td> <td>NOCE ITALIA</td> <td>italy walnut</td> </tr> <tr> <td>920</td> <td>ACERO</td> <td>maple</td> </tr> <tr> <td>929</td> <td>ROVERE AFRO</td> <td>african oak</td> </tr> <tr> <td>940</td> <td>BIANCO BR.</td> <td>br. white</td> </tr> <tr> <td>990</td> <td>WENGÉ</td> <td>wenge</td> </tr> </tbody> </table> <p>STRUTTURA INTERNA: BIANCO BR. internal structure: br. white</p>	(*)	FRONTALI - BASE FIANCHI FINALI - TOP	fronts - base final side panels - top	918	NOCE PACIFIC	pacific walnut	919	NOCE ITALIA	italy walnut	920	ACERO	maple	929	ROVERE AFRO	african oak	940	BIANCO BR.	br. white	990	WENGÉ	wenge
(*)	FRONTALI - BASE FIANCHI FINALI - TOP	fronts - base final side panels - top																										
918	NOCE PACIFIC	pacific walnut																										
919	NOCE ITALIA	italy walnut																										
920	ACERO	maple																										
929	ROVERE AFRO	african oak																										
940	BIANCO BR.	br. white																										
990	WENGÉ	wenge																										

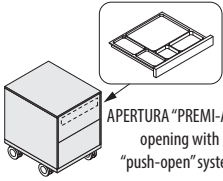
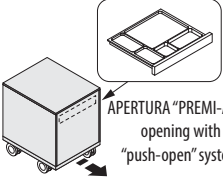
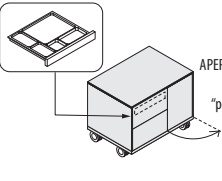
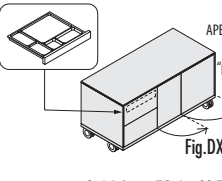
CASSETTIERE E MOBILI DI SERVIZIO SU RUOTE pedestals and service units on wheels																												
DESCRIZIONE description	L w	CODICE code	KG	M ³	COLLI	PREZZO price	(*) CODICE FINITURA (* finish code)																					
CASSETTIERA SU RUOTE 2 CASSETTI (CON 1 PORTA-CANCELLERIA INTERNO) pedestal on wheels with 2 drawers (with 1 internal stationery-tray)  APERTURA "PREMI-APRI" opening with "push-open" system L.44,2 x p.53,1 x H.59,7	L44,2	156 208 (*)	24	0,140	1	€ 450,00																						
CASSETTIERA-CLASSIFICATORE SU RUOTE (CON 1 PORTA-CANCELLERIA INTERNO) pedestal on wheels with 1 file-drawer (with 1 internal stationery-tray)  APERTURA "PREMI-APRI" opening with "push-open" system L.44,2 x p.53,1 x H.59,7	L44,2	156 209 (*)	22	0,140	1	€ 472,00																						
								<table border="1"> <thead> <tr> <th>(*)</th> <th>FRONTALI SCHIENA FIANCHI FINALI TOP</th> <th>fronts back panel final side panels top</th> </tr> </thead> <tbody> <tr> <td>400</td> <td>BIANCO BR.</td> <td>br. white</td> </tr> <tr> <td>418</td> <td>NOCE PACIFIC</td> <td>pacific walnut</td> </tr> <tr> <td>419</td> <td>NOCE ITALIA</td> <td>italy walnut</td> </tr> <tr> <td>420</td> <td>ACERO</td> <td>maple</td> </tr> <tr> <td>429</td> <td>ROVERE AFRO</td> <td>african oak</td> </tr> <tr> <td>490</td> <td>WENGÉ</td> <td>wenge</td> </tr> </tbody> </table>	(*)	FRONTALI SCHIENA FIANCHI FINALI TOP	fronts back panel final side panels top	400	BIANCO BR.	br. white	418	NOCE PACIFIC	pacific walnut	419	NOCE ITALIA	italy walnut	420	ACERO	maple	429	ROVERE AFRO	african oak	490	WENGÉ
(*)	FRONTALI SCHIENA FIANCHI FINALI TOP	fronts back panel final side panels top																										
400	BIANCO BR.	br. white																										
418	NOCE PACIFIC	pacific walnut																										
419	NOCE ITALIA	italy walnut																										
420	ACERO	maple																										
429	ROVERE AFRO	african oak																										
490	WENGÉ	wenge																										
MOBILE DI SERVIZIO L.75 SU RUOTE 2 CASSETTI (CON 1 PORTA-CANCELLERIA INTERNO) E 1 ANTA DX service unit w 75 cms on wheels with 2 drawers (with 1 internal stationery-tray) and 1 right door  APERTURA "PREMI-APRI" opening with "push-open" system L.75 x p.53,1 x H.59,7	L75	156 211 (*)	48,5	0,265	1	€ 554,00	STRUTTURA INTERNA: BIANCO BR. internal structure: br. white																					
MOBILE DI SERVIZIO L.116 SU RUOTE 2 CASSETTI (CON 1 PORTA-CANCELLERIA INTERNO) E 2 ANTE service unit w 116 cms on wheels with 2 drawers (with 1 internal stationery-tray) and 2 doors  APERTURA "PREMI-APRI" opening with "push-open" system Fig.DX/right L.116 x p.53,1 x H.59,7	DX right L.116	156 212 (*)	55	0,300	1	€ 725,00																						
	SX left L.116	156 213 (*)																										

ÉNOSI EVO

SCHEMA DI UTILIZZO CARTELLE SU CASSETTI CLASSIFICATORI/ scheme for using folders in file-drawers

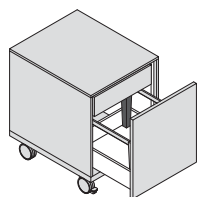

ART. 209



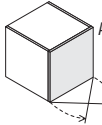
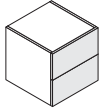
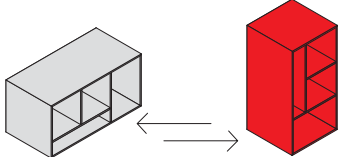
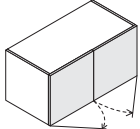
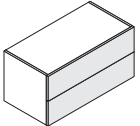

POS.	TIPO DI CARTELLA type of folder	INTERASSE CENTER DISTANCE (cm)
A	GRANDE EUROPA big Europe	cm 39
B	PICCOLA EUROPA little Europe	cm 33

 = CON DOTAZIONE STANDARD ARCHIVIAZIONE EUROPEA
 = European filing by standard outfit

"BUSSOLOTTI" COMPONENTI IN LARGHEZZA E ALTEZZA <i>modular units</i>							COMPLETARE SEMPRE CON BASE, FIANCHI FINALI E TOP (VEDI PAGINA SEGUENTE) always complete with base, final side-panels and top (please see next page)				
DESCRIZIONE <i>description</i>	L w	CODICE <i>code</i>	KG	M ³	COLLI	PREZZO <i>price</i>	(*) CODICE FINITURA <i>(*) finish code</i>				
BUSSOLOTTO L.45 CON 1 ANTA LEGNO DX O SX <i>modular unit w 45 cms with right or left wooden door</i>  APERTURA "PREMI-APRI" opening with "push-open" system L.45 x p.46,3 x H.45	L.45	156 214 (*)	11	0,147	3	€ 111,00					
								(*)	FRONTALI	STRUTTURA	fronts
							400	BIANCO BR.	BIANCO BR.	br. white	br. white
							418	NOCE PACIFIC BIANCO BR.		pacific walnut	br. white
							419	NOCE ITALIA	BIANCO BR.	italy walnut	br. white
							420	ACERO	BIANCO BR.	maple	br. white
							429	ROVERE AFRO	BIANCO BR.	african oak	br. white
							490	WENGÉ	BIANCO BR.	wenge	br. white
BUSSOLOTTO L.45 CON 2 CASSETTI <i>modular unit w 45 cms with 2 drawers</i>  APERTURA "PREMI-APRI" opening with "push-open" system L.45 x p.46,3 x H.45	L.45	156 215 (*)	8	0,158	1	€ 206,00					
ELEMENTO LIBRERIA L.90 <i>(utilizzabile in posizione orizzontale o verticale)</i> <i>modular bookcase w 90 cms</i> <i>(can be used in horizontal or vertical position)</i>  L.90 x p.46,3 x H.45	L.90	156 216 (*)	15	0,232	1	€ 526,00					
								(*)	ELEMENTO LACCATO	<i>lacquered element</i>	
							010	NERO	black		
							074	ROSSO	red		
							075	VERDE	green		
							078	BIANCO	white		
BUSSOLOTTO L.90 CON 2 ANTE LEGNO <i>modular unit w 90 cms with 2 wooden doors</i>  APERTURA "PREMI-APRI" opening with "push-open" system L.90 x p.46,3 x H.45	L.90	156 217 (*)	20	0,291	5	€ 189,00					
								(*)	FRONTALI	STRUTTURA	fronts
							400	BIANCO BR.	BIANCO BR.	br. white	br. white
							418	NOCE PACIFIC BIANCO BR.		pacific walnut	br. white
							419	NOCE ITALIA	BIANCO BR.	italy walnut	br. white
							420	ACERO	BIANCO BR.	maple	br. white
							429	ROVERE AFRO	BIANCO BR.	african oak	br. white
							490	WENGÉ	BIANCO BR.	wenge	br. white
BUSSOLOTTO L.90 CON 2 CASSETTI <i>modular unit w 90 cms with 2 drawers</i>  APERTURA "PREMI-APRI" opening with "push-open" system L.90 x p.46,3 x H.45	L.90	156 218 (*)	16	0,170	1	€ 264,00					

BASI, FIANCHI FINALI E TOP PER BUSSOLOTTI

bases, final side panels and top for modular units

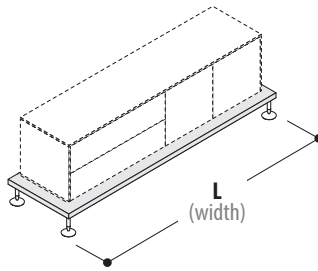
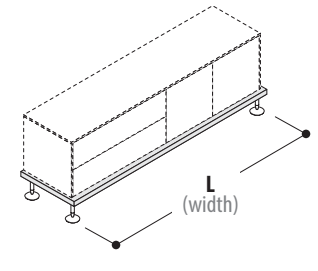
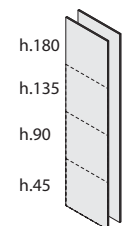
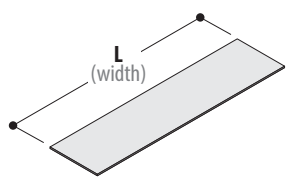
DESCRIZIONE <i>description</i>	L <i>w</i>	CODICE <i>code</i>	KG 	M ³ 	COLLI 	PREZZO <i>price</i>	(*) CODICE FINITURA <i>(*) finish code</i>																					
BASI PER BUSSOLOTTI (versione sporgente cm 9) <i>bases for modular units (protruding version 3 1/2")</i>  L. x p.56 x H.14	L.110	156 251 (*)	21	0,040	2	€ 290,00	<table border="1"> <thead> <tr> <th>(*)</th> <th>BASE</th> <th>base</th> </tr> </thead> <tbody> <tr> <td>918</td> <td>NOCE PACIFIC</td> <td><i>pacific walnut</i></td> </tr> <tr> <td>919</td> <td>NOCE ITALIA</td> <td><i>italy walnut</i></td> </tr> <tr> <td>920</td> <td>ACERO</td> <td><i>maple</i></td> </tr> <tr> <td>929</td> <td>ROVERE AFRO</td> <td><i>african oak</i></td> </tr> <tr> <td>940</td> <td>BIANCO BR.</td> <td><i>br. white</i></td> </tr> <tr> <td>990</td> <td>WENGÉ</td> <td><i>wenge</i></td> </tr> </tbody> </table>	(*)	BASE	base	918	NOCE PACIFIC	<i>pacific walnut</i>	919	NOCE ITALIA	<i>italy walnut</i>	920	ACERO	<i>maple</i>	929	ROVERE AFRO	<i>african oak</i>	940	BIANCO BR.	<i>br. white</i>	990	WENGÉ	<i>wenge</i>
	(*)	BASE	base																									
	918	NOCE PACIFIC	<i>pacific walnut</i>																									
	919	NOCE ITALIA	<i>italy walnut</i>																									
	920	ACERO	<i>maple</i>																									
929	ROVERE AFRO	<i>african oak</i>																										
940	BIANCO BR.	<i>br. white</i>																										
990	WENGÉ	<i>wenge</i>																										
L.200	156 253 (*)	30	0,067	2	€ 433,00																							
L.245	156 254 (*)	34	0,081	2	€ 512,00																							
L.290	156 255 (*)	52	0,094	2	€ 564,00																							
<table border="1"> <thead> <tr> <th>(*)</th> <th>BASE</th> <th>base</th> </tr> </thead> <tbody> <tr> <td>918</td> <td>NOCE PACIFIC</td> <td><i>pacific walnut</i></td> </tr> <tr> <td>919</td> <td>NOCE ITALIA</td> <td><i>italy walnut</i></td> </tr> <tr> <td>920</td> <td>ACERO</td> <td><i>maple</i></td> </tr> <tr> <td>929</td> <td>ROVERE AFRO</td> <td><i>african oak</i></td> </tr> <tr> <td>940</td> <td>BIANCO BR.</td> <td><i>br. white</i></td> </tr> <tr> <td>990</td> <td>WENGÉ</td> <td><i>wenge</i></td> </tr> </tbody> </table>							(*)	BASE	base	918	NOCE PACIFIC	<i>pacific walnut</i>	919	NOCE ITALIA	<i>italy walnut</i>	920	ACERO	<i>maple</i>	929	ROVERE AFRO	<i>african oak</i>	940	BIANCO BR.	<i>br. white</i>	990	WENGÉ	<i>wenge</i>	
(*)	BASE	base																										
918	NOCE PACIFIC	<i>pacific walnut</i>																										
919	NOCE ITALIA	<i>italy walnut</i>																										
920	ACERO	<i>maple</i>																										
929	ROVERE AFRO	<i>african oak</i>																										
940	BIANCO BR.	<i>br. white</i>																										
990	WENGÉ	<i>wenge</i>																										
BASI PER BUSSOLOTTI (versione sporgente cm 2) <i>bases for modular units (protruding version 3/4")</i>  L. x p.49,8 x H.14	L.96,3	156 281 (*)	20	0,034	2	€ 290,00																						
	L.186,2	156 283 (*)	28	0,057	2	€ 433,00																						
	L.231,1	156 284 (*)	31	0,070	2	€ 512,00																						
	L.276	156 285 (*)	49	0,079	2	€ 564,00																						
	<table border="1"> <thead> <tr> <th>(*)</th> <th>BASE</th> <th>base</th> </tr> </thead> <tbody> <tr> <td>918</td> <td>NOCE PACIFIC</td> <td><i>pacific walnut</i></td> </tr> <tr> <td>919</td> <td>NOCE ITALIA</td> <td><i>italy walnut</i></td> </tr> <tr> <td>920</td> <td>ACERO</td> <td><i>maple</i></td> </tr> <tr> <td>929</td> <td>ROVERE AFRO</td> <td><i>african oak</i></td> </tr> <tr> <td>940</td> <td>BIANCO BR.</td> <td><i>br. white</i></td> </tr> <tr> <td>990</td> <td>WENGÉ</td> <td><i>wenge</i></td> </tr> </tbody> </table>							(*)	BASE	base	918	NOCE PACIFIC	<i>pacific walnut</i>	919	NOCE ITALIA	<i>italy walnut</i>	920	ACERO	<i>maple</i>	929	ROVERE AFRO	<i>african oak</i>	940	BIANCO BR.	<i>br. white</i>	990	WENGÉ	<i>wenge</i>
(*)	BASE	base																										
918	NOCE PACIFIC	<i>pacific walnut</i>																										
919	NOCE ITALIA	<i>italy walnut</i>																										
920	ACERO	<i>maple</i>																										
929	ROVERE AFRO	<i>african oak</i>																										
940	BIANCO BR.	<i>br. white</i>																										
990	WENGÉ	<i>wenge</i>																										
COPPIA FIANCHI FINALI PER BUSSOLOTTI <i>set of 2 final side panels for modular units</i>  sp.1,2 x p.46,3 x H.	H.45	156 256 (*)	13	0,027	1	€ 68,00	<table border="1"> <thead> <tr> <th>(*)</th> <th>BASE</th> <th>base</th> </tr> </thead> <tbody> <tr> <td>180</td> <td>NOCE PACIFIC</td> <td><i>pacific walnut</i></td> </tr> <tr> <td>190</td> <td>NOCE ITALIA</td> <td><i>italy walnut</i></td> </tr> <tr> <td>200</td> <td>ACERO</td> <td><i>maple</i></td> </tr> <tr> <td>290</td> <td>ROVERE AFRO</td> <td><i>african oak</i></td> </tr> <tr> <td>400</td> <td>BIANCO BR.</td> <td><i>br. white</i></td> </tr> <tr> <td>900</td> <td>WENGÉ</td> <td><i>wenge</i></td> </tr> </tbody> </table>	(*)	BASE	base	180	NOCE PACIFIC	<i>pacific walnut</i>	190	NOCE ITALIA	<i>italy walnut</i>	200	ACERO	<i>maple</i>	290	ROVERE AFRO	<i>african oak</i>	400	BIANCO BR.	<i>br. white</i>	900	WENGÉ	<i>wenge</i>
	(*)	BASE	base																									
	180	NOCE PACIFIC	<i>pacific walnut</i>																									
	190	NOCE ITALIA	<i>italy walnut</i>																									
	200	ACERO	<i>maple</i>																									
290	ROVERE AFRO	<i>african oak</i>																										
400	BIANCO BR.	<i>br. white</i>																										
900	WENGÉ	<i>wenge</i>																										
H.90	156 257 (*)	17	0,030	1	€ 113,00																							
H.135	156 258 (*)	19	0,032	1	€ 158,00																							
H.180	156 259 (*)	21	0,035	1	€ 208,00																							
<table border="1"> <thead> <tr> <th>(*)</th> <th>BASE</th> <th>base</th> </tr> </thead> <tbody> <tr> <td>180</td> <td>NOCE PACIFIC</td> <td><i>pacific walnut</i></td> </tr> <tr> <td>190</td> <td>NOCE ITALIA</td> <td><i>italy walnut</i></td> </tr> <tr> <td>200</td> <td>ACERO</td> <td><i>maple</i></td> </tr> <tr> <td>290</td> <td>ROVERE AFRO</td> <td><i>african oak</i></td> </tr> <tr> <td>400</td> <td>BIANCO BR.</td> <td><i>br. white</i></td> </tr> <tr> <td>900</td> <td>WENGÉ</td> <td><i>wenge</i></td> </tr> </tbody> </table>							(*)	BASE	base	180	NOCE PACIFIC	<i>pacific walnut</i>	190	NOCE ITALIA	<i>italy walnut</i>	200	ACERO	<i>maple</i>	290	ROVERE AFRO	<i>african oak</i>	400	BIANCO BR.	<i>br. white</i>	900	WENGÉ	<i>wenge</i>	
(*)	BASE	base																										
180	NOCE PACIFIC	<i>pacific walnut</i>																										
190	NOCE ITALIA	<i>italy walnut</i>																										
200	ACERO	<i>maple</i>																										
290	ROVERE AFRO	<i>african oak</i>																										
400	BIANCO BR.	<i>br. white</i>																										
900	WENGÉ	<i>wenge</i>																										
TOP PER BUSSOLOTTI <i>top for modular units</i>  L. x p.46,3 x H.1,2	L.92,4	156 266 (*)	4	0,018	1	€ 58,00																						
	L.182,4	156 268 (*)	7	0,035	1	€ 108,00																						
	L.227,4	156 269 (*)	9	0,046	1	€ 129,00																						
	L.272,4	156 270 (*)	11	0,052	1	€ 153,00																						
	<table border="1"> <thead> <tr> <th>(*)</th> <th>BASE</th> <th>base</th> </tr> </thead> <tbody> <tr> <td>180</td> <td>NOCE PACIFIC</td> <td><i>pacific walnut</i></td> </tr> <tr> <td>190</td> <td>NOCE ITALIA</td> <td><i>italy walnut</i></td> </tr> <tr> <td>200</td> <td>ACERO</td> <td><i>maple</i></td> </tr> <tr> <td>290</td> <td>ROVERE AFRO</td> <td><i>african oak</i></td> </tr> <tr> <td>400</td> <td>BIANCO BR.</td> <td><i>br. white</i></td> </tr> <tr> <td>900</td> <td>WENGÉ</td> <td><i>wenge</i></td> </tr> </tbody> </table>							(*)	BASE	base	180	NOCE PACIFIC	<i>pacific walnut</i>	190	NOCE ITALIA	<i>italy walnut</i>	200	ACERO	<i>maple</i>	290	ROVERE AFRO	<i>african oak</i>	400	BIANCO BR.	<i>br. white</i>	900	WENGÉ	<i>wenge</i>
(*)	BASE	base																										
180	NOCE PACIFIC	<i>pacific walnut</i>																										
190	NOCE ITALIA	<i>italy walnut</i>																										
200	ACERO	<i>maple</i>																										
290	ROVERE AFRO	<i>african oak</i>																										
400	BIANCO BR.	<i>br. white</i>																										
900	WENGÉ	<i>wenge</i>																										

ENOSI EVO

ESEMPI DI COMPONENTABILITA' BUSSOLOTTI

examples of using modular units

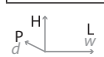
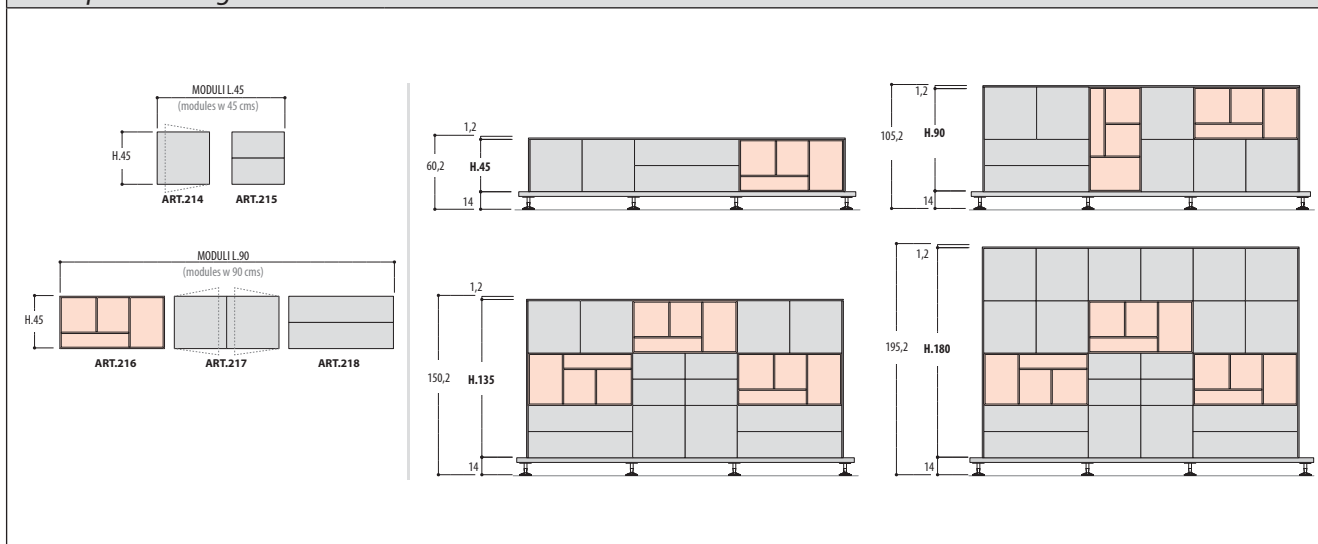

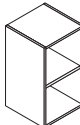
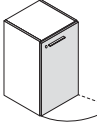
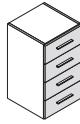
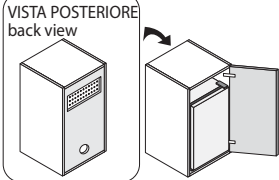
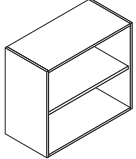
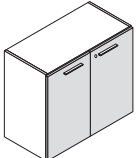

MOBILI BASSI <i>low cabinets</i>		TUTTE LE COMPOSIZIONI CON I MOBILI CONTENITORI DEVONO ESSERE COMPLETATE CON BASE, TOP + 2 FIANCHI FINALI (VEDI PAG. 21) always complete the compositions with base, top + 2 final side panels (please see page 21)					
DESCRIZIONE <i>description</i>	L w	CODICE <i>code</i>	KG	M ³	COLLI	PREZZO <i>price</i>	(*) CODICE FINITURA <i>(*) finish code</i>
MOBILE BASSO A GIORNO L.45 <i>open low cabinet w 45 cms</i>  L.45 x p.44,5 x H.78,7	L.45	156 900 (*)	20	0,047	2	€ 94,00	(*)
	(SENZA FORI PER CERNIERE) / (without holes for hinges)						STRUTTURA <i>structure</i>
MOBILE BASSO L.45 CON 1 ANTA LEGNO CON CHIUSURA AMMORTIZZATA E SERRATURA <i>low cabinet w 45 cms with 1 soft-close wooden door and lock</i>  Fig.DX/right L.45 x p.46,3 x H.78,7	DX right L.45	156 901 (*)	27	0,071	4	€ 166,00	
	SX left L.45	156 902 (*)					
MOBILE BASSO L.45 CON 4 CASSETTI CON CHIUSURA AMMORTIZZATA <i>low cabinet w 45 cms with 4 soft-close drawers</i>  L.45 x p.46,3 x H.78,7	L.45	156 903 (*)	31	0,230	1	€ 266,00	(*)
							FRONTALI <i>fronts</i>
						STRUTTURA <i>structure</i>	418 NOCE PACIFIC pacific walnut br. white
							419 NOCE ITALIA italy walnut br. white
							420 ACERO maple br. white
							429 ROVERE AFRO african oak br. white
							490 WENGÉ wenge br. white
MOBILE BASSO L.45 CON 1 ANTA LEGNO DX CON CHIUSURA AMMORTIZZATA E SERRATURA, COMPLETO DI FRIGORIFERO DA LT. 38+ GRIGLIA DI AERAZIONE <i>low cabinet w 45 cms with 1 soft-close right wooden door and lock, with refrigerator 38 liters+airing grid</i> VISTA POSTERIORE <i>back view</i>  L.45 x p.46,3 x H.78,7	DX right L.45	156 904 (*)	46	0,185	5	€ 978,00	
	DIMENSIONI FRIGORIFERO: L.39 x p.40 x H.54,2 <i>dimensions of refrigerator: w 39 x d 40 x h 54,2</i>						
MOBILE BASSO A GIORNO L.90 <i>open low cabinet w 90 cms</i>  L.90 x p.44,5 x H.78,7	L.90	156 909 (*)	31	0,072	2	€ 135,00	(*)
	(SENZA FORI PER CERNIERE) / (without holes for hinges)						STRUTTURA <i>structure</i>
MOBILE BASSO L.90 CON 2 ANTE LEGNO CON CHIUSURA AMMORTIZZATA E SERRATURA <i>low cabinet w 90 cms with 2 soft-close wooden doors and lock</i>  L.90 x p.46,3 x H.78,7	L.90	156 906 (*)	43	0,107	4	€ 277,00	(*)
							FRONTALI <i>fronts</i>
						STRUTTURA <i>structure</i>	418 NOCE PACIFIC pacific walnut br. white
							419 NOCE ITALIA italy walnut br. white
							420 ACERO maple br. white
							429 ROVERE AFRO african oak br. white
							490 WENGÉ wenge br. white

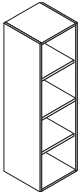
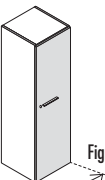
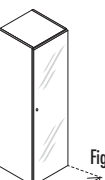
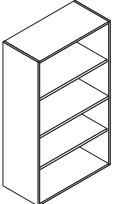
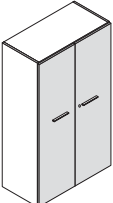
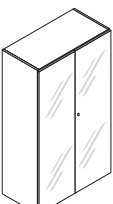

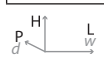

MOBILI MEDI medium cabinets		TUTTE LE COMPOSIZIONI CON I MOBILI CONTENITORI DEVONO ESSERE COMPLETATE CON BASE, TOP + 2 FIANCHI FINALI (VEDI PAG. 21) always complete the compositions with base, top + 2 final side panels (please see page 21)							
DESCRIZIONE description	L w	CODICE code	KG	M ³	COLLI	PREZZO price	PREZZO price	(*) CODICE FINITURA (* finish code)	
MOBILE MEDIO A GIORNO L.45 open medium cabinet w 45 cms 	L.45	156 915 (*)	36	0,088	3		€ 165,00	(*)	
	(SENZA FORI PER CERNIERE) / (without holes for hinges)							400	STRUTTURA bianco BR.
L.45 x p.44,5 x H.155,5									
MOBILE MEDIO L.45 CON 1 ANTA LEGNO CON CHIUSURA AMMORTIZZATA E SERRATURA medium cabinet w 45 cms with 1 soft-close wooden door and lock 	DX right	L.45	156 910 (*)	47	0,134	5	€ 286,00	(*)	
	SX left	L.45	156 911 (*)					ANTE	STRUTTURA
L.45 x p.46,3 x H.155,5									
MOBILE MEDIO L.45 CON 1 ANTA VETRO CON SERRATURA medium cabinet w 45 cms with 1 glass door with lock 	DX right	L.45	156 912 (*)	49	0,132	5	VETRO COLORATO coloured glass	VETRO BIANCO EXTRA extra white glass	
	SX left	L.45	156 913 (*)				€ 370,00	€ 403,00	
L.45 x p.46,3 x H.155,5									
VETRO TEMPERATO RETROLACCATO tempered rear-lacquered glass ANTA CON TELAIO ALLUMINIO E VETRO TEMPERATO RETRO-LACCATO door with aluminium frame and tempered rear-lacquered glass									
(*) ANTE STRUTTURA doors structure 410 NERO BIANCO BR. black br. white 474 ROSSO RUBINO BIANCO BR. ruby red br. white 475 PISTACCHIO BIANCO BR. pistachio br. white (*) ANTE STRUTTURA doors structure 478 BIANCO EXTRA BIANCO BR. extra white br. white									
MOBILE MEDIO A GIORNO L.90 open medium cabinet w 90 cms 	L.90	156 916 (*)	57	0,135	3		€ 244,00	(*)	
	(SENZA FORI PER CERNIERE) / (without holes for hinges)							400	STRUTTURA bianco BR.
L.90 x p.44,5 x H.155,5									
MOBILE MEDIO L.90 CON 2 ANTE LEGNO CON CHIUSURA AMMORTIZZATA E SERRATURA medium cabinet w 90 cms with 2 soft-close wooden doors and lock 	L.90	156 914 (*)	78	0,202	5		€ 476,00	(*)	
								400	STRUTTURA bianco BR.
L.90 x p.46,3 x H.155,5									
MOBILE MEDIO L.90 CON 2 ANTE VETRO CON SERRATURA medium cabinet w 90 cms with 2 glass doors with lock 	L.90	156 917 (*)	80	0,220	6		€ 670,00	€ 736,00	
								€ 670,00	€ 736,00
L.90 x p.46,3 x H.155,5									
ANTE CON TELAIO ALLUMINIO E VETRO TEMPERATO RETRO-LACCATO doors with aluminium frame and tempered rear-lacquered glass VETRO TEMPERATO RETROLACCATO tempered rear-lacquered glass VETRO TEMPERATO RETROLACCATO BIANCO EXTRA extra white tempered rear-lacquered glass									
(*) ANTE STRUTTURA doors structure 410 NERO BIANCO BR. black br. white 474 ROSSO RUBINO BIANCO BR. ruby red br. white 475 PISTACCHIO BIANCO BR. pistachio br. white (*) ANTE STRUTTURA doors structure 478 BIANCO EXTRA BIANCO BR. extra white br. white									

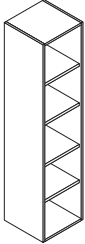
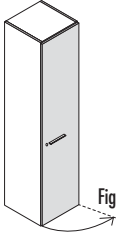
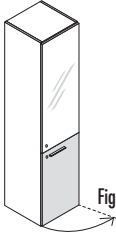
ÉNOSI EVO



MOBILI ALTI <i>high cabinets</i>		TUTTE LE COMPOSIZIONI CON I MOBILI CONTENITORI DEVONO ESSERE COMPLETATE CON BASE, TOP + 2 FIANCHI FINALI (VEDI PAG. 21) always complete the compositions with base, top + 2 final side panels (please see page 21)						
DESCRIZIONE <i>description</i>	L <i>w</i>	CODICE <i>code</i>	KG 	M ³ 	COLLI 	PREZZO <i>price</i>	PREZZO <i>price</i>	(*) CODICE FINITURA <i>(*) finish code</i>
MOBILE ALTO A GIORNO L.45 <i>open high cabinet w 45 cms</i>  L.45 x p.44,5 x H.193,9	L.45	156 920 (*)	47	0,104	3		€ 199,00	(*)
	(SENZA FORI PER CERNIERE) / (without holes for hinges)							400
MOBILE ALTO L.45 CON 1 ANTA LEGNO CON CHIUSURA AMMORTIZZATA E SERRATURA <i>high cabinet w 45 cms</i> <i>with 1 soft-close wooden door and lock</i>  Fig.DX/right L.45 x p.46,3 x H.193,9	DX <i>right</i>	L.45	156 918 (*)	57	0,149	5	€ 366,00	(*)
	SX <i>left</i>	L.45	156 919 (*)					ANTA BIANCO BR. / <i>door</i> <i>br. white</i>
MOBILE ALTO L.45 CON 1 ANTA LEGNO CON CHIUSURA AMMORTIZZATA E SERRATURA + 1 ANTA VETRO CON SERRATURA <i>high cabinet w 45 cms</i> <i>with 1 soft-close wooden door and lock + 1 glass door with lock</i>  Fig.DX/right L.45 x p.46,3 x H.193,9	DX <i>right</i>	L.45	156 922 (*)	63	0,163	7	€ 445,00 / € 470,00 VETRO COLORATO <i>coloured glass</i> / VETRO BIANCO EXTRA <i>extra white glass</i>	(*)
	SX <i>left</i>	L.45	156 923 (*)					ANTA CON TELAIO ALLUMINIO E VETRO TEMPERATO RETRO-LACCATO <i>door with aluminium frame and tempered rear-lacquered glass</i>
MOBILE ALTO L.45 CON 1 ANTA VETRO CON SERRATURA <i>high cabinet w 45 cms with 1 glass door with lock</i>  Fig.DX/right L.45 x p.46,3 x H.193,9	DX <i>right</i>	L.45	156 924 (*)	63	0,158	5	€ 433,00 / € 473,00 VETRO COLORATO <i>coloured glass</i> / VETRO BIANCO EXTRA <i>extra white glass</i>	(*)
	SX <i>left</i>	L.45	156 925 (*)					ANTA CON TELAIO ALLUMINIO E VETRO TEMPERATO RETRO-LACCATO <i>door with aluminium frame and tempered rear-lacquered glass</i>

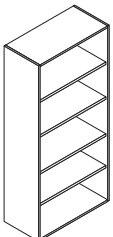
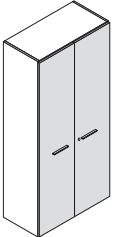
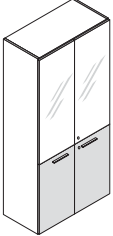

MOBILI ALTI high cabinets		TUTTE LE COMPOSIZIONI CON I MOBILI CONTENITORI DEVONO ESSERE COMPLETATE CON BASE, TOP + 2 FIANCHI FINALI (VEDI PAG. 21) always complete the compositions with base, top + 2 final side panels (please see page 21)						
DESCRIZIONE description	L w	CODICE code	KG	M ³	COLLI	PREZZO price	PREZZO price	(*) CODICE FINITURA (* finish code)
MOBILE ALTO A GIORNO L.90 open high cabinet w 90 cms 	L.90	156 927 (*)	73	0,162	3		€ 290,00	(*)
	(SENZA FORI PER CERNIERE) / (without holes for hinges)							400
L.90 x p.44,5 x H.193,9								
MOBILE ALTO L.90 CON 2 ANTE LEGNO CON CHIUSURA AMMORTIZZATA E SERRATURA high cabinet w 90 cms with 2 soft-close wooden doors and lock 	L.90	156 926 (*)	98	0,249	5		€ 594,00	(*)
								400
L.90 x p.46,3 x H.193,9								
MOBILE ALTO L.90 CON 2 ANTE LEGNO CON CHIUSURA AMMORTIZZATA E SERRATURA + 2 ANTE VETRO CON SERRATURA high cabinet w 90 cms with 2 soft-close wooden doors and lock + 2 glass doors with lock 	L.90	156 930 (*)	103	0,263	8		€ 787,00	(*)
								401
L.90 x p.46,3 x H.193,9								
MOBILE ALTO L.90 CON 2 ANTE VETRO CON SERRATURA high cabinet w 90 cms with 2 glass doors with lock 	L.90	156 932 (*)	102	0,268	6		€ 777,00	(*)
								410
L.90 x p.46,3 x H.193,9								

VETRO TEMPERATO RETROLACCATO
tempered rear-lacquered glass

(*)	ANTE LEGNO	ANTE VETRO	wooden doors	glass doors
181	NOCE PACIFIC NERO		pacific walnut	black
184	NOCE PACIFIC ROSSO RUBINO		pacific walnut	ruby red
185	NOCE PACIFIC PISTACCHIO		pacific walnut	pistachio
191	NOCE ITALIA NERO		italy walnut	black
194	NOCE ITALIA ROSSO RUBINO		italy walnut	ruby red
195	NOCE ITALIA PISTACCHIO		italy walnut	pistachio
201	ACERO NERO		maple	black
204	ACERO ROSSO RUBINO		maple	ruby red
205	ACERO PISTACCHIO		maple	pistachio
291	ROVERE AFRO NERO		african oak	black
294	ROVERE AFRO ROSSO RUBINO		african oak	ruby red
295	ROVERE AFRO PISTACCHIO		african oak	pistachio
401	BIANCO BR. NERO		br. white	black
404	BIANCO BR. ROSSO RUBINO		br. white	ruby red
405	BIANCO BR. PISTACCHIO		br. white	pistachio
901	WENGÉ NERO		wenge	black
904	WENGÉ ROSSO RUBINO		wenge	ruby red
905	WENGÉ PISTACCHIO		wenge	pistachio

STRUTTURA: BIANCO BR. / structure: br. white

VETRO TEMPERATO RETROLACCATO BIANCO EXTRA
extra white tempered rear-lacquered glass

(*)	ANTE LEGNO	ANTE VETRO	wooden doors	glass doors
188	NOCE PACIFIC BIANCO EXTRA		pacific walnut	extra white
198	NOCE ITALIA BIANCO EXTRA		italy walnut	extra white
208	ACERO BIANCO EXTRA		maple	extra white
298	ROVERE AFRO BIANCO EXTRA		african oak	extra white
408	BIANCO BR. BIANCO EXTRA		br. white	extra white
908	WENGÉ BIANCO EXTRA		wenge	extra white

STRUTTURA: BIANCO BR. / structure: br. white

VETRO TEMPERATO RETROLACCATO
tempered rear-lacquered glass



(*)	ANTE	STRUTTURA	doors	structure
410	NERO	BIANCO BR.	black	br. white
474	ROSSO RUBINO	BIANCO BR.	ruby red	br. white
475	PISTACCHIO	BIANCO BR.	pistachio	br. white

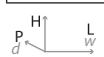

VETRO TEMPERATO RETROLACCATO BIANCO EXTRA
extra white tempered rear-lacquered glass

(*)	ANTE	STRUTTURA	doors	structure
478	BIANCO EXTRA	BIANCO BR.	extra white	br. white

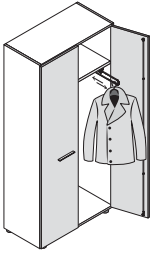

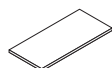
ENOSI EVO

MOBILI ALTI <i>high cabinets</i>		TUTTE LE COMPOSIZIONI CON I MOBILI CONTENITORI DEVONO ESSERE COMPLETATE CON BASE, TOP + 2 FIANCHI FINALI (VEDI PAG. 21) always complete the compositions with base, top + 2 final side panels (please see page 21)					
DESCRIZIONE <i>description</i>	L w	CODICE <i>code</i>	KG	M ³	COLLI	PREZZO <i>price</i>	(*) CODICE FINITURA <i>(*) finish code</i>
MOBILE ALTO L.90 CON 2 ANTE LEGNO CON CHIUSURA AMMORTIZZATA CON SERRATURA E 2 APPENDIABITI ESTRAIBILI <i>high cabinet w 90 cms with 2 soft-close wooden doors+lock and 2 pull-out clothes-hanger rails</i>  L.90 x p.46,3 x H.193,9	L.90	156 934 (*)	83	0,213	5	€ 568,00	(*) ANTE STRUTTURA <i>doors structure</i>
							400 BIANCO BR. BIANCO BR. <i>br. white br. white</i>
							418 NOCE PACIFIC BIANCO BR. <i>pacific walnut br. white</i>
							419 NOCE ITALIA BIANCO BR. <i>italy walnut br. white</i>
							420 ACERO BIANCO BR. <i>maple br. white</i>
							429 ROVERE AFRO BIANCO BR. <i>african oak br. white</i>
							490 WENGÉ BIANCO BR. <i>wenge br. white</i>
1 RIPIANO REGISTRABILE SUPPLEMENTARE PER MOBILI L.45 <i>1 adjustable additional shelf for cabinets w 45 cms</i>  L.41,2 x p. 40,6 x H.2,5	L.41,2	156 936 (*)	3	0,009	1	€ 14,00	(*) ANTE STRUTTURA <i>doors structure</i>
							400 BIANCO BR. BIANCO BR. <i>br. white br. white</i>
1 RIPIANO REGISTRABILE SUPPLEMENTARE PER MOBILI L.90 <i>1 adjustable additional shelf for cabinets w 90 cms</i>  L.86,2 x p. 40,6 x H.2,5	L.86,2	156 937 (*)	6	0,018	1	€ 22,00	(*) ANTE STRUTTURA <i>doors structure</i>
							400 BIANCO BR. BIANCO BR. <i>br. white br. white</i>

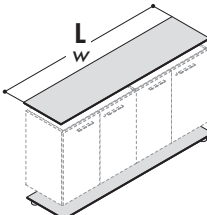
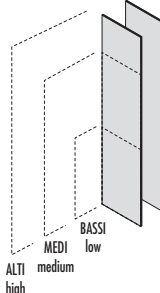
BASI, TOPS E FIANCHI FINALI <i>bases, tops and final side panels</i>																											
DESCRIZIONE <i>description</i>	L <i>w</i>	CODICE <i>code</i>	KG 	M ³ 	COLLI 	PREZZO <i>price</i>	(*) CODICE FINITURA <i>(*) finish code</i>																				
BASE+TOP PER MOBILI <i>base+top for cabinets</i>  L. x p.46,6 x H.4+1,2	L.92,7	156 804 (*)	10	0,018	1	€ 111,00																					
	L.137,6	156 805 (*)	11	0,035	1	€ 151,00																					
	L.182,6	156 806 (*)	12	0,050	1	€ 203,00																					
	L.227,5	156 807 (*)	13	0,046	1	€ 247,00																					
	L.272,5	156 808 (*)	13	0,052	1	€ 287,00																					
	COMPLETARE SEMPRE CON FIANCHI FINALI ART.952-953-954 <i>always complete with final side panels ART.952-953-954</i>																										
COPPIA FIANCHI FINALI PER MOBILI BASSI, MEDI E ALTI <i>set of 2 final side panels for low, medium and high cabinets</i>  sp.1,2 x p.46,5 x H.	H.78	156 952 (*)	12	0,020	1	€ 89,00																					
	H.154,8	156 953 (*)	14	0,023	1	€ 161,00																					
	H.193,2	156 954 (*)	19	0,027	1	€ 203,00																					
	COMPLETARE SEMPRE CON BASE+TOP <i>always complete with base+top</i> ART. 804-805-806-807-808																										
	<table border="1"> <thead> <tr> <th>(*)</th> <th></th> <th></th> </tr> </thead> <tbody> <tr> <td>180</td> <td>NOCE PACIFIC</td> <td><i>pacific walnut</i></td> </tr> <tr> <td>190</td> <td>NOCE ITALIA</td> <td><i>italy walnut</i></td> </tr> <tr> <td>200</td> <td>ACERO</td> <td><i>maple</i></td> </tr> <tr> <td>290</td> <td>ROVERE AFRO</td> <td><i>african oak</i></td> </tr> <tr> <td>400</td> <td>BIANCO BR.</td> <td><i>br. white</i></td> </tr> <tr> <td>900</td> <td>WENGÉ</td> <td><i>wenge</i></td> </tr> </tbody> </table>							(*)			180	NOCE PACIFIC	<i>pacific walnut</i>	190	NOCE ITALIA	<i>italy walnut</i>	200	ACERO	<i>maple</i>	290	ROVERE AFRO	<i>african oak</i>	400	BIANCO BR.	<i>br. white</i>	900	WENGÉ
(*)																											
180	NOCE PACIFIC	<i>pacific walnut</i>																									
190	NOCE ITALIA	<i>italy walnut</i>																									
200	ACERO	<i>maple</i>																									
290	ROVERE AFRO	<i>african oak</i>																									
400	BIANCO BR.	<i>br. white</i>																									
900	WENGÉ	<i>wenge</i>																									

ÉNOSI EVO

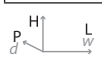
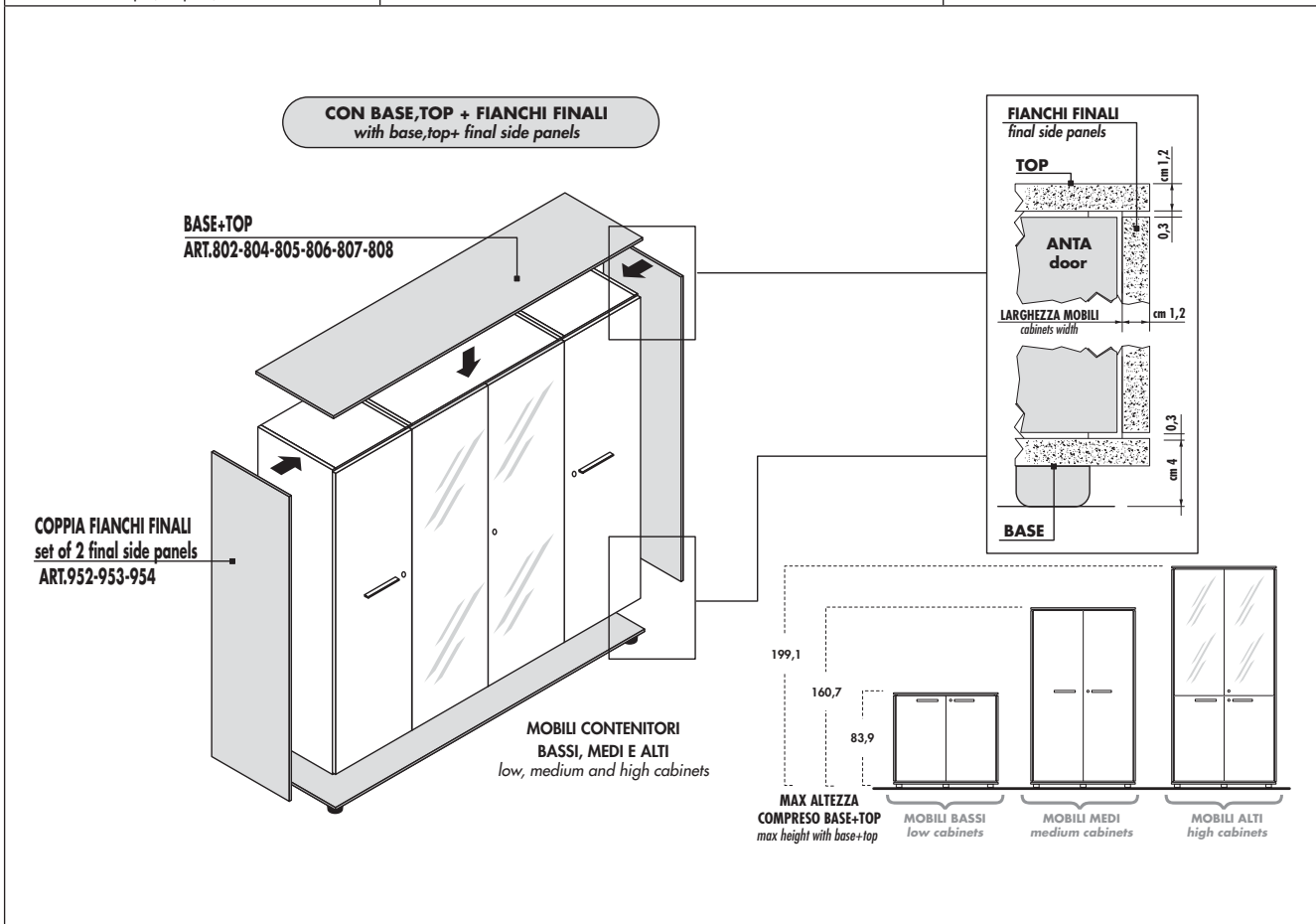

COMPOSIZIONI typicals

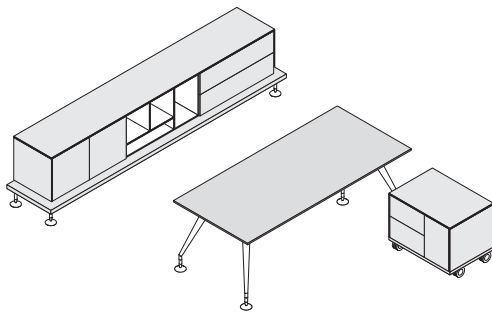

COMP. 01

Q.TÀ q./ty	CODICE code	DESCRIZIONE description	PREZZO UNITARIO unit price	PREZZO TOTALE total price
1	156 304 (*)	SCRIVANIA DIREZIONALE L.200 (GAMBE VERNICIATE) executive desk w 200 cms (painted legs)	€ 919,00	€ 919,00
1	156 211 (*)	MOBILE DI SERVIZIO L.75 SU RUOTE 2 CASSETTI E 1 ANTA DX O SX (CON PORTA-CANCELLERIA INTERNO) service unit w 75 cms on wheels with 2 drawers and 1 right or left door (with internal stationery-tray)	€ 554,00	€ 554,00
1	156 255 (*)	BASI PER BUSSOLOTTI L.290 bases for modular units w 290 cms	€ 564,00	€ 564,00
1	156 216 (*)	ELEMENTO LIBRERIA L.90 modular bookcase w 90 cms	€ 526,00	€ 526,00
1	156 217 (*)	BUSSOLOTTO L.90 CON 2 ANTE LEGNO modular unit w 90 cms with 2 wooden doors	€ 189,00	€ 189,00
1	156 218 (*)	BUSSOLOTTO L.90 CON 2 CASSETTI modular unit w 90 cms with 2 drawers	€ 264,00	€ 264,00
1	156 256 (*)	COPPIA FIANCHI FINALI PER BUSSOLOTTI H.45 set of 2 final side panels for modular units h.45 cms	€ 68,00	€ 68,00
1	156 270 (*)	TOP PER BUSSOLOTTI L.272,4 top for for modular units w 272,4 cms	€ 153,00	€ 153,00
(*) = INDICARE IL CODICE FINITURA = INDIQUER LE CODE FINITION = complete with finish code			TOT.	€ 3.237,00

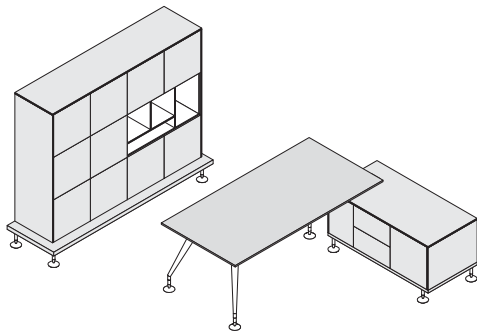

COMP. 02

Q.TÀ q./ty	CODICE code	DESCRIZIONE description	PREZZO UNITARIO unit price	PREZZO TOTALE total price
1	156 314 (*)	SCRIVANIA DIREZIONALI DX O SX (CON 1 DISTANZIALE) L.200 right or left executive desk (with 1 short leg) w 200 cms	€ 891,00	€ 891,00
1	156 223 (*)	MOBILE DI SERVIZIO L.122,5 DX O SX right or left service unit w 122,5 on adjustable feet	€ 919,00	€ 919,00
1	156 253 (*)	BASI PER BUSSOLOTTI L.200 bases for modular units w 200 cms	€ 433,00	€ 433,00
1	156 216 (*)	ELEMENTO LIBRERIA L.90 modular bookcase w 90 cms	€ 526,00	€ 526,00
5	156 217 (*)	BUSSOLOTTO L.90 CON 2 ANTE LEGNO modular unit w 90 cms with 2 wooden doors	€ 189,00	€ 945,00
1	156 258 (*)	COPPIA FIANCHI FINALI PER BUSSOLOTTI H.135 set of 2 final side panels for modular units h.135 cms	€ 158,00	€ 158,00
1	156 268 (*)	TOP PER BUSSOLOTTI L.182,4 top for for modular units w 182,4 cms	€ 108,00	€ 108,00
(*) = INDICARE IL CODICE FINITURA = INDIQUER LE CODE FINITION = complete with finish code			TOT.	€ 3.980,00

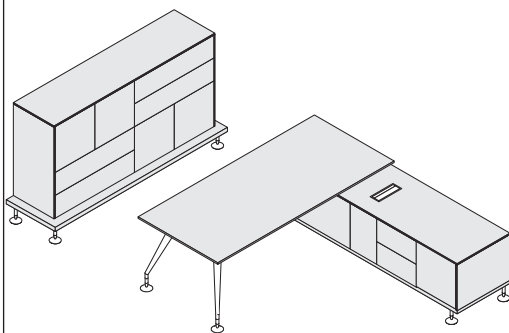

COMP. 03

Q.TÀ q./ty	CODICE code	DESCRIZIONE description	PREZZO UNITARIO unit price	PREZZO TOTALE total price
1	156 319 (*)	SCRIVANIA DIREZIONALE DX O SX (CON 2 DISTANZIALI) GAMBE VERNICIATE right or left executive desk (with 2 short legs) painted legs	€ 863,00	€ 863,00
1	156 226 (*)	MOBILE DI SERVIZIO L.212,3 DX O SX right or left service unit w 212,3 cms on adjustable feet	€ 1.052,00	€ 1.052,00
1	156 216 (*)	ELEMENTO LIBRERIA L.90 modular bookcase w 90 cms	€ 526,00	€ 526,00
1	156 253 (*)	BASI PER BUSSOLOTTI L.200 bases for modular units w 200 cms	€ 433,00	€ 433,00
2	156 217 (*)	BUSSOLOTTO L.90 CON 2 ANTE LEGNO modular unit w 90 cms with 2 wooden doors	€ 189,00	€ 378,00
2	156 218 (*)	BUSSOLOTTO L.90 CON 2 CASSETTI modular unit w 90 cms with 2 drawers	€ 264,00	€ 528,00
1	156 257 (*)	COPPIA FIANCHI FINALI PER BUSSOLOTTI H.90 set of 2 final side panels for modular units h.90 cms	€ 113,00	€ 113,00
1	156 268 (*)	TOP PER BUSSOLOTTI L.182,4 top for for modular units w 182,4 cms	€ 108,00	€ 108,00
(*) = INDICARE IL CODICE FINITURA = INDIQUER LE CODE FINITION = complete with finish code			TOT.	€ 4.001,00

DESCRIZIONE TECNICA

SCRIVANIE DIREZIONALI, ALLUNGHI E TAVOLI RIUNIONE

Piani di lavoro disponibili in 2 tipologie:

A) RIVESTITI CON 3D-FOIL EFFETTO LEGNO

B) IN VETRO TEMPERATO RETRO-LACCATO

Tipologia A)

Piano spessore totale mm 30 realizzato con pannello di fibra di legno MDF rivestito con 3d-foil disponibile nei colori: NOCE ITALIA 29, NOCE PACIFIC 37, WENGÉ 45, ROVERE AFRO 61, BIANCO BR. 69, ACERO 91.

Tipologia B)

Piano in cristallo temperato retro-laccato, spessore mm 12, bordi perimetrali lavorati a filo lucido piatto, disponibile nei colori: NERO 10, ROSSO RUBINO 74, VERDE PISTACCHIO 75 E BIANCO EXTRA 78.

I piani in cristallo sono ancorati alla struttura tramite incollaggio su supporti torniti in acciaio inox.

Gambe di sostegno

In tubo conificato da mm 1,5 di spessore disponibili in due versioni:

- versione verniciata, nei colori : BIANCO (BI 02) e NERO (NR 02)

- versione CROMATA LUCIDA.

Entrambe le tipologie hanno piedini livellatori presso-fusi in lega metallica cromata , con campo di regolazione di mm 20.

Telai strutturali

in tubolare metallico a sezione rettangolare 50 x 25 sp. mm.1,5, assemblati alle gambe tramite viti di fissaggio.

Modesty panel

Realizzati con pannello di fibra di legno (MDF) sp. mm 18 rivestito su un lato con 3d-foil, disponibile nei colori: ALLUMINIO MILLERIGHE, NOCE ITALIA 29, NOCE PACIFIC 37, WENGÉ 45, ROVERE AFRO 61, BIANCO BR. 69, ACERO 91. Sono ancorati al telaio strutturale mediante staffe di sostegno .

CASSETTIERE E MOBILI DI SERVIZIO

Cassettiera e mobili di servizio sono costituiti da una struttura primaria interna realizzata con pannelli di particelle di legno composite decorate sp. mm 18 di colore BIANCO BR. 69, e da una parte esterna di finitura costituita da fianchi finali, basi, top , pannello posteriore.

Le componenti della parte esterna sono realizzate con pannelli di fibra di legno MDF rivestiti con 3d-foil disponibili nei colori: NOCE ITALIA 29, NOCE PACIFIC 37, WENGÉ 45, ROVERE AFRO 61, BIANCO BR. 69, ACERO 91.

Cassettiere e mobili di servizio, sono dotati di ruote pivottanti gemellate in nylon rivestito in gomma, con perno di supporto e rivestimento laterale cromato, freno stabilizzatore per le ruote anteriori.

I mobili di servizio vengono realizzati anche su piedini livellatori metallici e vengono utilizzati anche come basamento delle scrivanie.

La struttura dei cassetti è costituita da spondine e fondo in fibra rivestiti in pvc bianco che scorrono su guide metalliche con cuscinetti in nylon dotati di fine corsa in apertura e self-closing in chiusura. L'apertura è senza maniglia perché le guide sono dotate di sistema premi-apri.

Le cassettiere ed i mobili di servizio su ruote sono dotati di porta-cancelleria estraibile posizionato all'interno del cassetto superiore, realizzato in MDF rivestito con 3d-foil con scomparti per I-PAD e telefoni cellulari.

BUSSOLOTTI COMPONIBILI

I contenitori sono del tipo componibile , costituiti dai seguenti elementi: bussolotti strutturali con ante o cassetti , base livellabile, top superiore, fianchi di finitura. I bussolotti sono disponibili nelle dimensioni L. 45/90 x H.45, assemblabili e sovrapponibili fra loro in modo da creare composizioni di mobili di varie dimensioni e da rifinire sempre con base strutturale, fianchi finali e top di finitura.

La carcassa dei bussolotti è costituita da pannelli di particelle di legno composite decorate sp. mm 18 disponibili nella sola versione colore BIANCO BR. 69.

La base strutturale è realizzata con pannello di spessore mm 30 rivestito con foglia polimerica termoformabile disponibile nei colori: NOCE ITALIA 29, NOCE PACIFIC 37, WENGÉ 45, ROVERE AFRO 61, BIANCO BR. 69, ACERO 91.

E' dotata di piedini livellatori presso-fusi in lega metallica cromata lucida uguali a quelli del basamento metallico delle scrivanie.

Il top, i fianchi di finitura e le ante sono realizzati con pannelli di fibra di legno MDF rivestiti con 3d-foil, disponibili nei colori: NOCE ITALIA 29, NOCE PACIFIC 37, WENGÉ 45, ROVERE AFRO 61, BIANCO BR. 69, ACERO 91. Top e fianchi finali hanno spessore mm.12, le ante mm.18.

Le ante non presentano maniglia in quanto sono dotate di sistema premi-apri. Tutte le cerniere sono del tipo con ala e scatola metallica con 3 campi di regolazione.

Le composizioni di mobili possono essere integrate con un elemento-libreria aperto realizzato con sistema folding in MDF di spessore mm.12 e laccato nei colori BIANCO, NERO, ROSSO e VERDE. Le dimensioni di tale elemento sono L.90 x p.46,3 x H.45.

MOBILI CONTENITORI

Sono disponibili nelle larghezze cm 45 e cm 90 ed in 3 diverse tipologie in altezza: bassi, medi e alti.

La struttura è realizzata con pannelli di particelle di legno composite decorate sp. mm 18 (sp.mm25 per i ripiani) colore BIANCO BR. 69 , rifiniti perimetralmente con bordo melaminico sp. mm 0,4 in tinta con la superficie ed è dotata di piedini livellatori.

La struttura dei cassetti è costituita da spondine e fondo in fibra rivestiti in pvc nero che scorrono su guide metalliche con cuscinetti in nylon dotati di fine corsa in apertura e chiusura ammortizzata.

Le ante ed i frontali dei cassetti sono realizzati con pannelli di fibra di legno MDF sp. mm 18 rivestiti con 3d-foil disponibili nei colori: NOCE ITALIA 29, NOCE PACIFIC 37, WENGÉ 45, ROVERE AFRO 61, BIANCO BR. 69 , ACERO 91. Le ante legno basse e medie sono dotate di serratura a paletto, le ante alte sono dotate di serratura ad aste rotanti con 2 punti di chiusura.

Le ante vetrate sono con serratura, senza maniglia, con con telaio perimetrale in alluminio anodizzato (a scomparsa) e vetro temperato retro-laccato sp. mm 4 nei colori: NERO 10, ROSSO RUBINO 74, PISTACCHIO 75, BIANCO EXTRA 78.

Tutte le ante legno sono dotate di sistema di ammortizzamento soft-closing. Le maniglie sono metalliche con finitura cromata.

Le composizioni dei mobili sono da completare sempre con base+top di finitura+fianchi finali (forniti a parte) .

BASE, TOP DI FINITURA E FIANCHI FINALI

Sono realizzati con pannelli di fibra di legno MDF sp. mm 12, rivestiti con 3d-foil disponibili nei colori: NOCE ITALIA 29, NOCE PACIFIC 37, WENGÉ 45, ROVERE AFRO 61, BIANCO BR. 69 , ACERO 91.

IMBALLO

Tutti i componenti sono forniti smontati ed imballati con involucro pieghevole in cartone triplo, listelli di protezione perimetrale e per i riempimenti ove occorre.

Gli angoli sono protetti , ove occorre, con paraspighi anti-urto. La chiusura dell'imballo avviene mediante nastro adesivo e reggetta in nylon termosaldato.

Le cassettiere sono fornite montate, protette sui lati con angolari in cartone ed imballate con foglia di polietilene termoretraibile.

CARATTERISTICHE FISICO-MECCANICHE DEI PANNELLI DI PARTICELLE DI LEGNO DI SPESSORE mm 18 NOBILITATI IN MELAMINICO:		
DESCRIZIONE	VALORE MINIMO	NORMA DI RIFERIMENTO
Massa volumica	650 Kg / m ³ ± 10%	UNI EN 323 :1994
Umidità relativa	5 - 13%	UNI EN 322 :1994
Tolleranza spessore	± 0,3 mm	UNI EN 324-1/1994
Rigonfiamento a 24 ore	15%	UNI EN 317 :1994
Distacco strati esterni	0,8 Mpa	UNI EN 311 :2003
Flessione statica	16 Mpa	UNI EN 310 :1994
Modulo di elasticità	1600 Mpa	UNI EN 310 :1994
Estrazione viti sui bordi	> 400 N	UNI EN 320 :1994
Contenuto di formaldeide	≤ a 3,5 mg H ₂ CO (m ² x h)	UNI EN ISO 12460 - 3:2015

TECHNICAL DESCRIPTION

EXECUTIVE DESKS, EXTENSIONS AND MEETING TABLES

The work top is available in two constructive types:

A)- COVERED WITH 3D-FOIL

B)- IN TOUGHENED GLASS REAR-LACQUERED

Type A)

Total thickness of the work top 30mm, made from an MDF wooden fibre panel covered with 3d-foil , available in the colours: ITALY WALNUT 29, PACIFIC WALNUT 37, WENGE 45, AFRICAN OAK 61, BR. WHITE 69, MAPLE 91.

Type B)

Work top made from toughened glass with a satin effect, 12mm thick, with lipped shiny flat edges, available in the colours: BLACK 10, RUBY RED 74 , PISTACHE 75, EXTRA WHITE 78.

Supporting legs

Made from a 1,5 mm thick coned tube, available in 2 version:

- painted version in colours: WHITE (BI 02) and BLACK (NR 02)

- shiny chromed version.

Both versions are equipped with die-cast levelling feet made from a chromed steel alloy, with a regulation of 20mm.

Structural beams are made from rectangular steel tubes 50x25, 1,5 mm thick, which are fixed to the conical supporting legs by screws.

Modesty panel

Made from 18mm thick MDF wooden fibre panel covered with 3d-foil. Available in the colour ALUMINIUM STRIPED EFFECT 00, ITALY WALNUT 29, PACIFIC WALNUT 37, WENGE 45, AFRICAN OAK 61, BR. WHITE 69, MAPLE 91. They are suspended from the structural beams using supporting brackets.

PEDESTALS AND SERVICE UNITS

Pedestals and service units are made from an internal primary structure with 18mm thick decorated wood based panels in an BR. WHITE 69 colour and an external finishing part made from finishing side panels, bases, top and back panel.

The components of the external finishing part are made from an MDF wooden fibre panel covered with 3d-foil available in colours: ITALY WALNUT 29, PACIFIC WALNUT 37, WENGE 45, AFRICAN OAK 61, BR. WHITE 69, MAPLE 91.

Pedestals and service units are fitted with pirouetting nylon wheels covered in rubber with a supporting pin and a chromed side finish, with a stabilizer brake for the front wheels.

Internal drawers made of fibreboard covered with white PVC that slide on metal glides with nylon bearings, with drawer opening stopper and self-closing system. The opening is no handle because the guides are equipped with push-open system.

The pedestals and service units on wheels are equipped of internal stationery-tray.

The pedestals and service units on wheels are fitted with pull-out stationery holder placed inside the upper drawer, made of MDF covered with thermoformed polymeric sheet (HDPC) with compartments for I-PAD and mobile phones.

MODULAR UNITS

The cabinets are made up of the following elements:

Structure of modular unit with doors or drawers, adjustable base, finishing top, finishing side panels.

The modular units are available in widths of w 45/90 x h 45 cms assemblable and overlapping so as to create various compositions of furniture of various sizes and to be finished always with structural base, final side panels and finish top.

The structure of modular units is made from 18mm thick decorated wood based panels and only available in BR.WHITE 69.

The base is made from 30mm thick wooden fibre panel covered with 3d-foil available in the colours: ITALY WALNUT 29, PACIFIC WALNUT 37, WENGE 45, AFRICAN OAK 61, BR. WHITE 69, MAPLE 91. The base is fitted with levelling feet

The top, final side panels and the doors are made from an MDF wooden fibre panel (12mm thick for top and final side panels, 18 mm thick. for doors) covered with 3d-foil available in the colours: ITALY WALNUT 29, PACIFIC WALNUT 37, WENGE 45, AFRICAN OAK 61, BR. WHITE 69, MAPLE 91.

The doors are fitted with push/open system, all of the hinges have a wing and a steel box with 3 fields of regulation.

The compositions of furniture can be integrated with an open-bookcase made with folding system in 12mm MDF and painted in WHITE, BLACK, RED and GREEN. The dimensions of this element are w 90 x d 46,3 x h 45 cms.

CABINETS

Are available in the width 45cm and 90cm and in 3 different height measurements: low, medium and high cabinets.

The structure is made from 18mm thick (25mm thick for shelves) decorated wood based panels and only available in BR.WHITE 69, perimetrically finished with melamine edge of 0.4mm thick in the same colour as the surface and fitted with leveller feet.

Internal drawers made of fibreboard covered with black PVC that slide on metal glides with nylon bearings, with drawer opening stopper and soft-closing system.

The doors and the frontals of drawers are made from 18mm thick wooden fibre panel covered with 3d-foil available in the colours: ITALY WALNUT 29, PACIFIC WALNUT 37, WENGE 45, AFRICAN OAK 61, BR. WHITE 69, MAPLE 91. The low and medium wooden doors are fitted with sliding bar locks , the high doors are fitted with a rotating rod lock with 2 locking points.

The glazed doors are without handle, with lock, with anodised aluminium perimeter hidden frame and 4 mm tempered glass rear-lacquered in colours: BLACK 10, RUBY RED 74, PISTACHIO 75, EXTRA WHITE 78.

All the wooden doors are finished with damping system for soft-closing. The handles are made of metal with a chrome finish.

The cabinets are always complete with base+top finish + final sides panels.

BASE, FINISHING TOPS AND FINAL SIDE PANELS

They are made with MDF type fibreboard panels of 12mm thick covered with 3d-foil available in the colours: ITALY WALNUT 29, PACIFIC WALNUT 37, WENGE 45, AFRICAN OAK 61, BR. WHITE 69, MAPLE 91.

PACKAGING

All the components are disassembled and packed when supplied, and have paper triple type folding packaging, fillets for the perimetrical protection and for the fillings up, where needed . The corners are protected, where needed, through shock resistant edges protector. The packing closure occurs through sticky tape and welded nylon strap. Pedestals are assembled, when supplied, protected through polystyrene angle bars on the sides and packed using thermo-retractable polyethylene leave when provided.

PHYSICAL-MECHANICAL CHARACTERISTICS OF 18 MM THICK PARTICLEBOARD PANELS, MELAMINE-FACED:		
DESCRIPTION	MINIMUM VALUE	STANDARD NUMBERS
Volume Mass	650 Kg / m ³ ± 10%	UNI EN 323 :1994
Relative Humidity	5 - 13%	UNI EN 322 :1994
Thickness Allowance	± 0,3 mm	UNI EN 324-1/1994
24 hour Swelling	15%	UNI EN 317 :1994
External Surfaces Detachment	0,8 Mpa	UNI EN 311 :2003
Static Flexure	16 Mpa	UNI EN 310 :1994
Elastic Modulus	1600 Mpa	UNI EN 310 :1994
Edge Screws Extraction	> 400 N	UNI EN 320 :1994
Formaldehyde Content	≤ a 3,5 mg H ₂ CO (m ² x h)	UNI EN ISO 12460 - 3:2015

INDICE DEI CODICI
codes index

INDICE DEI CODICI / codes index
Mod. ENOSI EVO

* = INDICARE IL CODICE FINITURA
= complete with finish code

CODICE code	DESCRIZIONE description	PAG. page	PREZZO price	PREZZO price
156 208 *	CASSETTIERA SU RUOTE 2 CASSETTI (CON 1 PORTA-CANCELLERIA INTERNO) pedestal on wheels with 2 drawers (with 1 internal stationery-tray)	13	€ 450,00	€ -
156 209 *	CASSETTIERA CLASSIFICATORE SU RUOTE (CON 1 PORTA-CANCELLERIA INTERNO) pedestal on wheels with 1 file-drawer (with 1 internal stationery-tray)	13	€ 472,00	€ -
156 211 *	MOBILE DI SERVIZIO L.75 SU RUOTE 2 CASSETTI (CON 1 PORTA-CANCELLERIA INTERNO) E 1 ANTA DX O SX service unit w 75 cms on wheels 2 drawers (with 1 internal stationery-tray) and 1 right or left door	13	€ 554,00	€ -
156 212 *	MOBILE DI SERVIZIO L.116 SU RUOTE 2 CASSETTI (CON 1 PORTA-CANCELLERIA INTERNO) E 2 ANTE DX service unit w 116 cms on wheels 2 drawers (with 1 internal stationery-tray) and 2 right doors	13	€ 725,00	€ -
156 213 *	MOBILE DI SERVIZIO L.116 SU RUOTE 2 CASSETTI (CON 1 PORTA-CANCELLERIA INTERNO) E 2 ANTE SX service unit w 116 cms on wheels 2 drawers (with 1 internal stationery-tray) and 2 left doors	13	€ 725,00	€ -
156 214 *	BUSSOLOTTO L.45 CON 1 ANTA LEGNO DX O SX modular unit w 45 cms with right or left wooden door	14	€ 111,00	€ -
156 215 *	BUSSOLOTTO L.45 CON 2 CASSETTI modular unit w 45 cms with 2 drawers	14	€ 206,00	€ -
156 216 *	BUSSOLOTTO/LIBRERIA L.90 modular unit/bookcase w 90 cms	14	€ 526,00	€ -
156 217 *	BUSSOLOTTO L.90 CON 2 ANTE LEGNO modular unit w 90 cms with 2 wooden doors	14	€ 189,00	€ -
156 218 *	BUSSOLOTTO L.90 CON 2 CASSETTI modular unit w 90 cms with 2 drawers	14	€ 264,00	€ -
156 223 *	MOBILE DI SERVIZIO L.122,5 DX O SX SU PIEDINI right or left service unit w 122,5 cms on adjustable feet	12	€ 919,00	€ -
156 226 *	MOBILE DI SERVIZIO L.212,3 DX O SX SU PIEDINI right or left service unit w 212,3 cms on adjustable feet	12	€ 1.052,00	€ -
156 251 *	BASE PER BUSSOLOTTI L.110 (VERSIONE SPORGENTE CM 9) base for modular units w 110 cms (protruding version 9 cms)	15	€ 290,00	€ -
156 253 *	BASE PER BUSSOLOTTI L.200 (VERSIONE SPORGENTE CM 9) base for modular units w 200 cms (protruding version 9 cms)	15	€ 433,00	€ -
156 254 *	BASE PER BUSSOLOTTI L.245 (VERSIONE SPORGENTE CM 9) base for modular units w 245 cms (protruding version 9 cms)	15	€ 512,00	€ -
156 255 *	BASE PER BUSSOLOTTI L.290 (VERSIONE SPORGENTE CM 9) base for modular units w 290 cms (protruding version 9 cms)	15	€ 564,00	€ -
156 256 *	COPPIA FIANCHI FINALI PER BUSSOLOTTI H.45 set of 2 final side panels for modular units h.45 cms	15	€ 68,00	€ -
156 257 *	COPPIA FIANCHI FINALI PER BUSSOLOTTI H.90 set of 2 final side panels for modular units h.90 cms	15	€ 113,00	€ -
156 258 *	COPPIA FIANCHI FINALI PER BUSSOLOTTI H.135 set of 2 final side panels for modular units h.135 cms	15	€ 158,00	€ -
156 259 *	COPPIA FIANCHI FINALI PER BUSSOLOTTI H.180 set of 2 final side panels for modular units h.180 cms	15	€ 208,00	€ -
156 266 *	TOP L.92,4 top w 92,4 cms	15	€ 58,00	€ -
156 268 *	TOP L.182,4 top w 182,4 cms	15	€ 108,00	€ -
156 269 *	TOP L.227,4 top w 227,4 cms	15	€ 129,00	€ -
156 270 *	TOP L.272,4 top w 272,4 cms	15	€ 153,00	€ -
156 281 *	BASE PER BUSSOLOTTI L.96,3 (VERSIONE SPORGENTE CM 2) base for modular units w 96,3 (protruding version 2 cms)	15	€ 290,00	€ -
156 283 *	BASE PER BUSSOLOTTI L.186,2 (VERSIONE SPORGENTE CM 2) base for modular units w 186,2 cms (protruding version 2 cms)	15	€ 433,00	€ -
156 284 *	BASE PER BUSSOLOTTI L.231,1 (VERSIONE SPORGENTE CM 2) base for modular units w 231,1 cms (protruding version 2 cms)	15	€ 512,00	€ -
156 285 *	BASE PER BUSSOLOTTI L.276 (VERSIONE SPORGENTE CM 2) base for modular units w 276 cms (protruding version 2 cms)	15	€ 564,00	€ -
156 303 *	SCRIVANIA DIREZIONALE L.180 executive desk w 180 cms	5	€ 867,00	€ 1.047,00
156 304 *	SCRIVANIA DIREZIONALE L.200 executive desk w 200 cms	5	€ 919,00	€ 1.099,00
156 305 *	SCRIVANIA DIREZIONALE L.220 executive desk w 220 cms	5	€ 967,00	€ 1.147,00
156 313 *	SCRIVANIA DIREZIONALE L.180 DX O SX (CON 1 DISTANZIALE) right or left executive desk w 180 cms (with 1 short leg)	5	€ 839,00	€ 990,00
156 314 *	SCRIVANIA DIREZIONALE L.200 DX O SX (CON 1 DISTANZIALE) right or left executive desk w 200 cms (with 1 short leg)	5	€ 891,00	€ 1.042,00
156 315 *	SCRIVANIA DIREZIONALE L.220 DX O SX (CON 1 DISTANZIALE) right or left executive desk w 220 cms (with 1 short leg)	5	€ 939,00	€ 1.090,00
156 318 *	SCRIVANIA DIREZIONALE L.180 DX O SX (CON 2 DISTANZIALI) right or left executive desk w 180 cms (with 2 short legs)	5	€ 811,00	€ 933,00
156 319 *	SCRIVANIA DIREZIONALE L.200 DX O SX (CON 2 DISTANZIALI) right or left executive desk w 200 cms (with 2 short legs)	5	€ 863,00	€ 985,00
156 320 *	SCRIVANIA DIREZIONALE L.220 DX O SX (CON 2 DISTANZIALI) right or left executive desk w 220 cms (with 2 short legs)	5	€ 911,00	€ 1.033,00
156 323 *	ALLUNGO L.100 DX O SX right or left extension w 100 cms	5	€ 450,00	€ 540,00
156 324 *	ALLUNGO L.120 DX O SX right or left extension w 120 cms	5	€ 488,00	€ 578,00
156 352 *	TAVOLO RIUNIONE / SCRIVANIA L.200 meeting table / desk w 200 cms	8	€ 973,00	€ 1.153,00
156 373 *	TAVOLO RIUNIONE / SCRIVANIA L.200 DX O SX (CON 1 DISTANZIALE) right or left meeting table / desk w 200 cms (with 1 short leg)	5	€ 945,00	€ 1.096,00

ENOSI EVO

* = INDICARE IL CODICE FINITURA
= complete with finish code

CODICE code	DESCRIZIONE description	PAG. page	PREZZO price	PREZZO price
156 374 *	TAVOLO RIUNIONE QUADRATO L.120 x p.120 squared meeting table w 120 x d 120	8	€ 763,00	€ 943,00
156 375 *	TAVOLO RIUNIONE QUADRATO L.160 x p.160 CON CANALE PORTA-CAVI E TOP ACCESS squared meeting table w 160 x d 160 with cable-tray and top access	8	€ 1.547,00	€ 1.727,00
156 376 *	TAVOLO RIUNIONE CIRCOLARE Ø 120 circular meeting table Ø 120 cms	8	€ 643,00	€ 778,00
156 379 *	TAVOLO RIUNIONE RETTANGOLARE L.280 CON WIRE-MANAGER, CANALE PORTA-CAVI E TOP ACCESS rectangular meeting table w 280 cms with wire-manager, cable-tray and top access	9	€ 1.749,00	€ 1.929,00
156 380 *	TAVOLO RIUNIONE RETTANGOLARE L.320 CON WIRE-MANAGER, CANALE PORTA-CAVI E TOP ACCESS rectangular meeting table w 320 cms with wire-manager, cable-tray and top access	9	€ 2.199,00	€ 2.379,00
156 381 *	TAVOLO RIUNIONE RETTANGOLARE L.380 CON WIRE-MANAGER, CANALE PORTA-CAVI E TOP ACCESS rectangular meeting table w 380 cms with wire-manager, cable-tray and top access	9	€ 2.477,00	€ 2.657,00
156 393 *	CANALE PORTA-CAVI cable-tray	9	€ 21,00	€ -
156 396 *	MODESTY PANEL PER SCRIVANIA L.180 modesty panel for desk w 180 cms	7	€ 72,00	€ -
156 397 *	MODESTY PANEL PER SCRIVANIA L.200 modesty panel for desk w 200cms	7	€ 80,00	€ -
156 398 *	MODESTY PANEL PER SCRIVANIA L.220 modesty panel for desk w 220 cms	7	€ 88,00	€ -
156 401 *	SCRIVANIA DIREZIONALE L.180 CON PIANO IN VETRO executive desk w 180 cms with glass top	6	€ 1.125,00	€ 1.305,00
156 402 *	SCRIVANIA DIREZIONALE L.200 CON PIANO IN VETRO executive desk w 200 cms with glass top	6	€ 1.184,00	€ 1.364,00
156 403 *	SCRIVANIA DIREZIONALE L.220 CON PIANO IN VETRO executive desk w 220 cms with glass top	6	€ 1.264,00	€ 1.444,00
156 405 *	SCRIVANIA DIREZIONALE L.180 DX O SX CON PIANO IN VETRO (CON 1 DISTANZIALE) right or left executive desk w 180 cms with glass top (with 1 short leg)	6	€ 1.097,00	€ 1.248,00
156 406 *	SCRIVANIA DIREZIONALE L.200 DX O SX CON PIANO IN VETRO (CON 1 DISTANZIALE) right or left executive desk w 200 cms with glass top (with 1 short leg)	6	€ 1.156,00	€ 1.307,00
156 407 *	SCRIVANIA DIREZIONALE L.220 DX O SX CON PIANO IN VETRO (CON 1 DISTANZIALE) right or left executive desk w 220 cms with glass top (with 1 short leg)	6	€ 1.236,00	€ 1.387,00
156 409 *	SCRIVANIA DIREZIONALE L.180 DX O SX CON PIANO IN VETRO (CON 2 DISTANZIALI) right or left executive desk w 180 cms with glass top (with 2 short legs)	6	€ 1.069,00	€ 1.191,00
156 410 *	SCRIVANIA DIREZIONALE L.200 DX O SX CON PIANO IN VETRO (CON 2 DISTANZIALI) right or left executive desk w 200 cms with glass top (with 2 short legs)	6	€ 1.128,00	€ 1.250,00
156 411 *	SCRIVANIA DIREZIONALE L.220 DX O SX CON PIANO IN VETRO (CON 2 DISTANZIALI) right or left executive desk w 220 cms with glass top (with 2 short legs)	6	€ 1.208,00	€ 1.330,00
156 413 *	ALLUNGO L.100 DX O SX CON PIANO IN VETRO right or left extension w 100 cms with glass top	7	€ 578,00	€ 668,00
156 414 *	ALLUNGO L.120 DX O SX CON PIANO IN VETRO right or left extension w 120 cms with glass top	7	€ 612,00	€ 702,00
156 417 *	TAVOLO RIUNIONE / SCRIVANIA L.200 CON PIANO IN VETRO meeting table / desk w 200 cms with glass top	10	€ 1.455,00	€ 1.635,00
156 420 *	TAVOLO RIUNIONE / SCRIVANIA L.200 DX O SX CON PIANO IN VETRO (CON 1 DISTANZIALE) right or left meeting table / desk w 200 cms with glass top (with 1 short leg)	7	€ 1.427,00	€ 1.578,00
156 421 *	TAVOLO RIUNIONE QUADRATO L.120 x p.120 CON PIANO IN VETRO squared meeting table w 120 x d 120 with glass top	10	€ 1.037,00	€ 1.217,00
156 422 *	TAVOLO RIUNIONE QUADRATO L.160 x p.160 CON PIANO IN VETRO, CANALE PORTA-CAVI E TOP ACCESS squared meeting table w 160 x d 160 with glass top, cable-tray and top access	11	€ 1.895,00	€ 2.075,00
156 423 *	TAVOLO RIUNIONE CIRCOLARE Ø 120 CON PIANO IN VETRO circular meeting table Ø 120 cms with glass top	11	€ 981,00	€ 1.116,00
156 427 *	SCRIVANIA DIREZIONALE L.180 CON PIANO IN VETRO executive desk w 180 cms with glass top	6	€ 1.278,00	€ 1.458,00
156 428 *	SCRIVANIA DIREZIONALE L.200 CON PIANO IN VETRO executive desk w 200 cms with glass top	6	€ 1.353,00	€ 1.533,00
156 429 *	SCRIVANIA DIREZIONALE L.220 CON PIANO IN VETRO executive desk w 220 cms with glass top	6	€ 1.449,00	€ 1.629,00
156 430 *	SCRIVANIA DIREZIONALE L.180 DX O SX CON PIANO IN VETRO (CON 1 DISTANZIALE) right or left executive desk w 180 cms with glass top (with 1 short leg)	6	€ 1.250,00	€ 1.401,00
156 431 *	SCRIVANIA DIREZIONALE L.200 DX O SX CON PIANO IN VETRO (CON 1 DISTANZIALE) right or left executive desk w 200 cms with glass top (with 1 short leg)	6	€ 1.325,00	€ 1.476,00
156 432 *	SCRIVANIA DIREZIONALE L.220 DX O SX CON PIANO IN VETRO (CON 1 DISTANZIALE) right or left executive desk w 220 cms with glass top (with 1 short leg)	6	€ 1.421,00	€ 1.572,00
156 433 *	SCRIVANIA DIREZIONALE L.180 DX O SX CON PIANO IN VETRO (CON 2 DISTANZIALI) right or left executive desk w 180 cms with glass top (with 2 short legs)	6	€ 1.222,00	€ 1.344,00
156 434 *	SCRIVANIA DIREZIONALE L.200 DX O SX CON PIANO IN VETRO (CON 2 DISTANZIALI) right or left executive desk w 200 cms with glass top (with 2 short legs)	6	€ 1.297,00	€ 1.419,00
156 435 *	SCRIVANIA DIREZIONALE L.220 DX O SX CON PIANO IN VETRO (CON 2 DISTANZIALI) right or left executive desk w 220 cms with glass top (with 2 short legs)	6	€ 1.393,00	€ 1.515,00
156 436 *	ALLUNGO L.100 DX O SX CON PIANO IN VETRO right or left extension w 100 cms with glass top	7	€ 639,00	€ 729,00
156 437 *	ALLUNGO L.120 DX O SX CON PIANO IN VETRO right or left extension w 120 cms with glass top	7	€ 686,00	€ 776,00
156 440 *	TAVOLO RIUNIONE / SCRIVANIA L.200 CON PIANO IN VETRO meeting table / desk w 200 cms with glass top	10	€ 1.691,00	€ 1.871,00
156 443 *	TAVOLO RIUNIONE / SCRIVANIA L.200 DX O SX CON PIANO IN VETRO (CON 1 DISTANZIALE) right or left meeting table / desk w 200 cms with glass top (with 1 short leg)	7	€ 1.663,00	€ 1.814,00
156 444 *	TAVOLO RIUNIONE QUADRATO L.120 x p.120 CON PIANO IN VETRO squared meeting table w 120 x d 120 with glass top	10	€ 1.181,00	€ 1.361,00
156 445 *	TAVOLO RIUNIONE QUADRATO L.160 x p.160 CON PIANO IN VETRO, CANALE PORTA-CAVI E TOP ACCESS squared meeting table w 160 x d 160 with glass top, cable-tray and top access	11	€ 2.145,00	€ 2.325,00

* = INDICARE IL CODICE FINITURA
= complete with finish code

CODICE code	DESCRIZIONE description	PAG. page	PREZZO price	PREZZO price
156 446 *	TAVOLO RIUNIONE CIRCOLARE Ø 120 CON PIANO IN VETRO circular meeting table Ø 120 cms with glass top	11	€ 1.069,00	€ 1.204,00
156 804 *	BASE+TOP L.92,7	21	€ 111,00	€ -
156 805 *	BASE+TOP L.137,6	21	€ 151,00	€ -
156 806 *	BASE+TOP L.182,6	21	€ 203,00	€ -
156 807 *	BASE+TOP L.227,5	21	€ 247,00	€ -
156 808 *	BASE+TOP L.272,5	21	€ 287,00	€ -
156 900 *	MOBILE BASSOA GIORNO L.45 open low cabinet w 45 cms	16	€ 94,00	€ -
156 901 *	MOBILE BASSO L.45 CON 1 ANTA LEGNO DX CON CHIUSURA AMMORTIZZATA E SERRATURA low cabinet w 45 cms with 1 soft-close right wooden door and lock	16	€ 166,00	€ -
156 902 *	MOBILE BASSO L.45 CON 1 ANTA LEGNO SX CON CHIUSURA AMMORTIZZATA E SERRATURA low cabinet w 45 cms with 1 soft-close left wooden door and lock	16	€ 166,00	€ -
156 903 *	MOBILE BASSO L.45 CON 4 CASSETTI CON CHIUSURA AMMORTIZZATA low cabinet w 45 cms with 4 soft-close drawers	16	€ 266,00	€ -
156 904 *	MOBILE BASSO L.45 CON 1 ANTA LEGNO DX CON CHIUSURA AMMORTIZZATA E SERRATURA, COMPLETO DI FRIGORIFERO DA L1.38+GRIGLIA DI AERAZIONE low cabinet w 45 cms with 1 soft-close right wooden door and lock, with refrigerator 38 liters+airing grill	16	€ 978,00	€ -
156 906 *	MOBILE BASSO L.90 CON 2 ANTE LEGNO CON CHIUSURA AMMORTIZZATA E SERRATURA low cabinet w 90 cms with 2 soft-close wooden doors and lock	16	€ 277,00	€ -
156 909 *	MOBILE BASSOA GIORNO L.90 open low cabinet w 90 cms	16	€ 135,00	€ -
156 910 *	MOBILE MEDIO L.45 CON 1 ANTA LEGNO DX CON CHIUSURA AMMORTIZZATA E SERRATURA medium cabinet w 45 cms with 1 soft-close right wooden door and lock	17	€ 286,00	€ -
156 911 *	MOBILE MEDIO L.45 CON 1 ANTA LEGNO SX CON CHIUSURA AMMORTIZZATA E SERRATURA medium cabinet w 45 cms with 1 soft-close left wooden door and lock	17	€ 286,00	€ -
156 912 *	MOBILE MEDIO L.45 CON 1 ANTA VETRO DX CON SERRATURA medium cabinet w 45 cms with 1 right glass door with lock	17	€ 370,00	€ 403,00
156 913 *	MOBILE MEDIO L.45 CON 1 ANTA VETRO SX CON SERRATURA medium cabinet w 45 cms with 1 left glass door with lock	17	€ 370,00	€ 403,00
156 914 *	MOBILE MEDIO L.90 CON 2 ANTE LEGNO CON CHIUSURA AMMORTIZZATA E SERRATURA medium cabinet w 90 cms with 2 soft-close wooden doors and lock	17	€ 476,00	€ -
156 915 *	MOBILE MEDIO GIORNO L.45 open medium cabinet w 45 cms	17	€ 165,00	€ -
156 916 *	MOBILE MEDIO GIORNO L.90 open medium cabinet w 90 cms	17	€ 244,00	€ -
156 917 *	MOBILE MEDIO L.90 CON 2 ANTE VETRO CON SERRATURA medium cabinet w 90 cms with 2 glass doors with lock	17	€ 670,00	€ 736,00
156 918 *	MOBILE ALTO L.45 CON 1 ANTA LEGNO DX CON CHIUSURA AMMORTIZZATA E SERRATURA high cabinet w 45 cms with 1 soft-close right wooden door and lock	18	€ 366,00	€ -
156 919 *	MOBILE ALTO L.45 CON 1 ANTA LEGNO SX CON CHIUSURA AMMORTIZZATA E SERRATURA high cabinet w 45 cms with 1 soft-close left wooden door and lock	18	€ 366,00	€ -
156 920 *	MOBILE ALTO A GIORNO L.45 open high cabinet w 45	18	€ 199,00	€ -
156 922 *	MOBILE ALTO L.45 CON 1 ANTA LEGNO DX CON CHIUSURA AMMORTIZZATA E SERRATURA+ 1 ANTA VETRO DX CON SERR. high cabinet w 45 cms with 1 soft-close right wooden door and lock + 1 right glass door with lock	18	€ 445,00	€ 470,00
156 923 *	MOBILE ALTO L.45 CON 1 ANTA LEGNO SX CON CHIUSURA AMMORTIZZATA E SERRATURA+ 1 ANTA VETRO SX CON SERR. high cabinet w 45 cms with 1 soft-close left wooden door and lock + 1 left glass door with lock	18	€ 445,00	€ 470,00
156 924 *	MOBILE ALTO L.45 CON 1 ANTA VETRO DX CON SERRATURA high cabinet w 45 cms with 1 right glass door with lock	18	€ 433,00	€ 473,00
156 925 *	MOBILE ALTO L.45 CON 1 ANTA VETRO SX CON SERRATURA high cabinet w 45 cms with 1 left glass door with lock	18	€ 433,00	€ 473,00
156 926 *	MOBILE ALTO L.90 CON 2 ANTE LEGNO CON CHIUSURA AMMORTIZZATA E SERRATURA high cabinet w 90 cms with 2 soft-close wooden doors and lock	19	€ 594,00	€ -
156 927 *	MOBILE ALTO A GIORNO L.90 open high cabinet w 90	19	€ 290,00	€ -
156 930 *	MOBILE ALTO L.90 CON 2 ANTE LEGNO CON CHIUSURA AMMORTIZZATA E SERRATURA+ 2 ANTE VETRO CON SERR. high cabinet w 90 cms with 2 soft-close wooden doors and lock + 2 glass doors with lock	19	€ 787,00	€ 837,00
156 932 *	MOBILE ALTO L.90 CON 2 ANTE VETRO CON SERRATURA high cabinet w 90 cms with 2 glass doors with lock	19	€ 777,00	€ 859,00
156 934 *	MOBILE ALTO PORTA-ABITI L.90 CON 2 ANTE LEGNO CON CHIUSURA AMMORTIZZATA E SERRATURA high cabinet with wardrobe w 90 cms with 2 soft-close wooden doors and lock	20	€ 568,00	€ -
156 936 *	RIPIANO REGISTRABILE PER MOBILI L.45 adjustable shelf for cabinet w 45cms	20	€ 14,00	€ -
156 937 *	RIPIANO REGISTRABILE PER MOBILI L.90 adjustable shelf for cabinet w 90cms	20	€ 22,00	€ -
156 952 *	COPPIA FIANCHI FINALI PER MOBILI BASSI set of 2 final side-panels for low cabinets	21	€ 89,00	€ -
156 953 *	COPPIA FIANCHI FINALI PER MOBILI MEDI set of 2 final side-panels for medium cabinets	21	€ 161,00	€ -
156 954 *	COPPIA FIANCHI FINALI PER MOBILI ALTI set of 2 final side-panels for high cabinets	21	€ 203,00	€ -
OYO				
175 392 *	PASSACAPO Ø80MM CROMATO chromed cableway Ø80mm	9	€ 54,00	€ -